



**RIGID**[®]

OWN THE NIGHT  [™]

INTRO PRODUCT SPREAD COMING SOON

TABLE OF CONTENTS

3	Our Story
4	Manufacturing
5	Why RIGID
11	Adapt
15	D-SS
19	Radiance Pod
23	Radiance Bar
27	Chase
31	Reflect
33	Ignite
37	Midnight Edition
41	Capture
43	RDS-Series
47	E-Series
51	SR-Series
55	D-Series
59	Dually XL
63	Q-Series
67	SR-Q Series
71	SR-M Series
75	A-Series
77	R-Series 46
81	R-Series 36
85	Scene Lights
89	Site Series
93	RI-Series
95	Headlight Kits
97	E-Mark Compliant
98	SAE Compliant
99	High & Low
101	Amber & White
102	Amber Lights
103	MIL-STD-461F
104	Infrared
105	Lighting Kits
111	LED Grilles & OE Mounts
129	Accessories

RIGID INGENUITY

OUR STORY

In 2006, Rigid Industries LED Lighting introduced the E-Series LED Light Bar, the first of its kind in the LED lighting industry. Since then, RIGID has led the forward projecting LED lighting industry in innovation, light output and efficiency. Up until that time, the industry had focused on traditional incandescent light for racing and recreational applications, but the advanced LED lighting technology, combined with the patented Hybrid, Specter, and Hyperspot optics that offered more lighting at a fraction of the power consumption quickly revolutionized lighting in the off-road industry. Our patented optic systems effectively control the beam of light emitted by the LED, which translates to more light where you want it with very little wasted spill light. Since the introduction of our first product, our design and engineering teams are constantly developing new and innovative quality products using the latest in LED technology.

While RIGID started as an off-road lighting company, we quickly realized that our advanced lighting technologies could be applied to many other industries. RIGID currently produces lighting for the automotive, power sports, agriculture, marine, mining/construction, military, police and fire rescue industries, just to name a few. We take pride in the fact that our LED lighting products are designed, engineered, and assembled in the USA. This not only builds our local economy, but it also allows RIGID to maintain the high level of quality that you've come to expect from RIGID products. This level of refinement and quality control is what separates RIGID from the rest.

In 2015 RIGID announced its acquisition by Truck-Lite®. Together, RIGID and Truck-Lite now offer the complete package of DOT, off-road and accessory LED lighting for not only on and off-road markets, but for markets from around the world in a wide variety of heavy-duty and commercial vehicle categories. RIGID and Truck-Lite take pride in the fact that our products are designed, engineered and assembled in the USA, employing over 2,400 people and counting. Both RIGID and Truck-Lite look forward to expanding our presence and products around the globe.



MANUFACTURING

RIGID products are proudly designed, engineered, assembled and tested in our **ISO 9001:2008** facility in the United States. Currently, we have three locations in the greater Phoenix Metro area with a combination of 74,000 square feet. Our highly skilled and motivated workforce takes pride in the fact that RIGID LED lighting products are built in the USA. This not only helps build our local economy, but allows us to remain hands-on, ensuring you will continue to receive the highest level of quality that you've come to expect from RIGID.

We go the distance by requiring extra testing and certifications for heavy-duty vibration, dust, moisture and corrosion resistance on our lights and brackets. This ensures that we have a product that we can stand behind, no matter the industry or application it is used for and we back all of our products with a Limited Lifetime Warranty. Quality workmanship, combined with innovative technologies allows us to produce the best forward projecting LED lights on the market.



BUILD QUALITY

DON'T BE FOOLED BY OTHERS

RIGID VS OTHERS



1. BOARDS

RIGID

1.A

Aluminum PCB Smart Boards™

1.B

Copper thermal conductive pad

1.C

Gold plated electrical contacts

OTHERS

1.A

Cost-cutting stock boards

2. LEDs

RIGID

2.A

Hand selected brightest high-tech LEDs from America's best LED manufacturers.

OTHERS

2.A

Falsely claiming use of name brand LEDs (Cree), cheap, less advanced LEDs

3. OPTICS

RIGID

3.A

RIGID invests heavily in optical science and has developed multiple patented optics that maximize the total light output and efficiency.

OTHERS

3.A

Simple non-engineered reflector dishes that scatter the light.

4. CONNECTIONS

RIGID

4.A

Waterproof connector mates with the supplied wiring harness.

OTHERS

4.A

Blunt cut wires and no wiring harness, switch, or relay.

5. LENS & SEALS

RIGID

5.A

Impact Resistant Polycarbonate Lens that will never yellow.

5.B

Custom molded synthetic polymer gaskets create a 100% water/dustproof.

5.C

GORE® Pressure Equalizing Vent. (not shown)

OTHERS

5.A

Light diffusing glass or inferior plastics will quickly crack, scratch, and yellow.

5.B

Hand-applied household silicone seal, no pressure vent.

6. COATING

RIGID

6.A

6063-T5 aircraft aluminum extruded housings treated with Alodine® corrosion preventive and Tiger Drylac® UV protectant polyester powder coating.

6.B

Corrosion-proof chrome-plated 304 stainless steel hardware.

OTHERS

6.A

Thin-wall low-grade aluminum material with Single coat black paint that quickly fades when exposed to the sun.

6.B

Zinc or non-coated hardware quickly corrodes under harsh environments or salt exposure.

REAL COST OF OWNERSHIP

Exclusions May Apply

RIGID
VS
OTHERS = **REAL COST**
\$\$\$\$
\$\$\$\$\$



ORIGINAL LIGHT COST

\$\$\$\$
VS
\$\$



HARNESS, SWITCH & RELAY

INCLUDED
VS
+\$



WARRANTY

INCLUDED
VS
NONE
OR LIMITED



OUTPUT PER LIGHT

MAXIMUM
VS
+\$
MULTIPLE LIGHTS NEEDED



DE MOUNTS & ACCESSORIES

OFFERED
VS
NONE
OR LIMITED

WARRANTY

If you own a RIGID light and it breaks, we will replace or repair it for life.



CUSTOMER SERVICE

RIGID
VS
OTHERS

DEDICATED USA BASED
VS
WHO DO YOU CALL?



SHIP PRODUCT TO FACILITY

US ADDRESS
VS
NOWHERE TO SEND IT?



PRODUCT SERVICE

REPAIRED OR REPLACED
VS
NOT COVERED
OR REPLACED WITH ANOTHER INFERIOR PRODUCT



PRODUCT

MADE IN THE USA
VS
WHO KNOWS WHERE THE LIGHTS ARE MADE?



WARRANTY URL

www.rigidindustries.com/about/warranty

HOW TO CHOOSE AN OPTIC

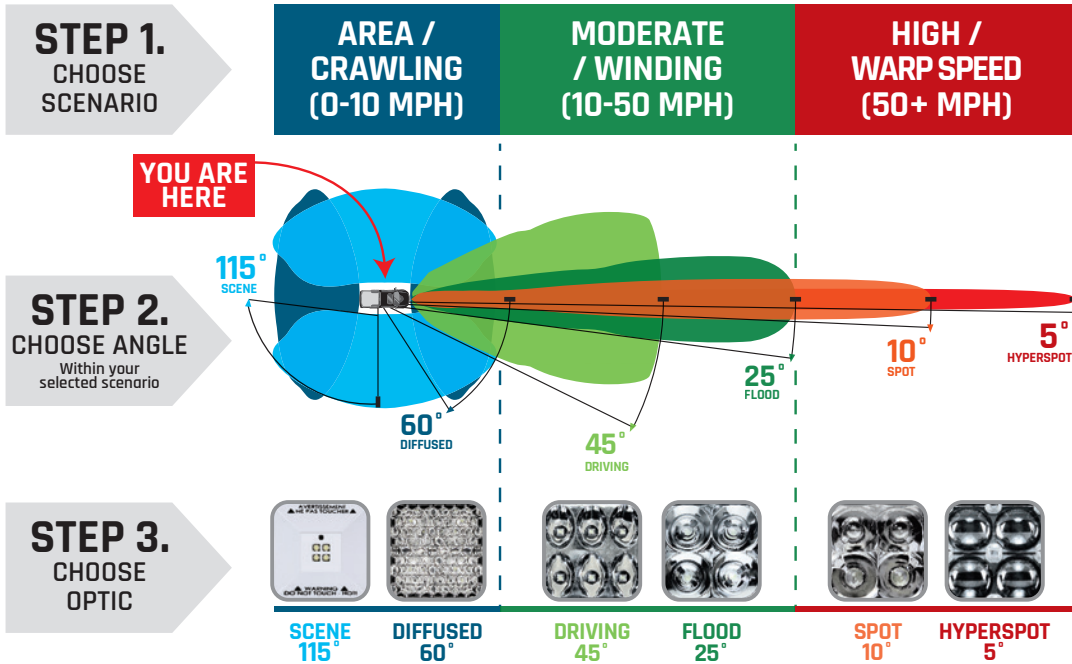

NEW
WEB BASED
APPLICATION

RIGID VIEWPOINT

**SELECT LIGHTS & OPTICS
THEN COMPARE IN REAL WORLD SCENE**

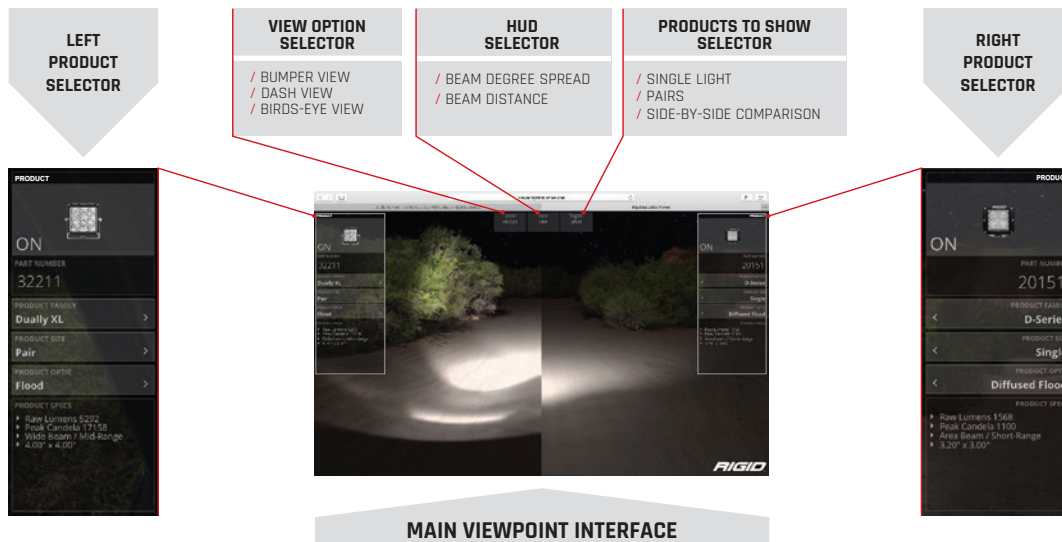

VIEWPOINT URL

www.rigidindustries.com/viewpoint

HOW TO NAVIGATE THIS CATALOG

Follow the Navigation Key below to find information needed to help you through the process of choosing the light or lights that are right for you.

NAVIGATION KEY



PRODUCT DESCRIPTION

FORM FACTOR

FEATURES

DIMENSIONS & MOUNTS

BEAM PATTERN

SPECIFICATIONS

LIGHTS COME WITH

LIGHTS

pg 11 - pg 104

BUILD INCLUDES

Radiance Pod | PG. 19

Radiance Bar | PG. 23





ADAPT™

The RIGID Adapt LED Light Bars are the world's first off-road lighting products that can change instantly according to conditions. Adapt offers 8 selectable beam patterns that range from broad short-distance lighting to highly focused long-distance lighting in a single fixture. It also includes RIGID's new Active View™ Technology, which allows the beam pattern to actively adjust with vehicle speed. There are no moving parts within the Adapt. Instead, RIGID uses advanced LED technology and combines it with patented new optics to create a revolutionary lighting solution that can Adapt with changing conditions. Further, Adapt has built-in accent lighting that can be set to any color in the light spectrum, including white, for a custom look around town. The Adapt has a signature new look that is unlike any other light bar on the market, and it even has expanded mounting capabilities that include new base-mounting options. Traditional side mounts are also present, which are compatible with existing RIGID mounting brackets. Adapt LED light bars include a RIGID Dash Controller, which is a molded backlit dash-mounted unit that offers easy, intuitive control of Adapt's beam patterns, Adaptive Mode, accent lighting, and programmable presets. RIGID Adapt Light Bars are available in 10-inch to 50-inch lengths and include a wiring harness, RIGID Dash Controller, and mounting hardware.



**8 MODE -
ACTIVE VIEW
TECHNOLOGY**



BUILT IN RGB-W ACCENT LIGHTING



FEATURES

- 50,000+ Hour Lifespan
- 9-36 V DC
- Durable UV Polyester Powder Coat
- GORE® Pressure Equalizing Vent
- Harness & Dash Controller Included
- High-Grade Aluminum Alloy Heatsink
- Integrated Thermal Management System
- Impact Resistant Polycarbonate Lens
- IP68 Compliant - Dust / Water Ingress
- Mounting Brackets Included
- Over / Under Voltage Protection
- Operating Temp -40° F ~ +145° F / -40° C ~ +60° C
- Protected Against RFI / EMI
- Patented Technology
- Reverse Polarity Protection
- RoHS Compliant
- SAE J575 Compliant - Shock / Vibration

DASH CONTROLLER



- Active View Technology - Automatically Change Beam Patterns Based On Vehicle Speed
- Dash Controller with Wiring Harness
- 8 Selectable Beam Patterns From 15-Degrees to 90-Degrees
- Integrated Optic Design with Spot, Flood, and Driving Zones
- Selectable RGB-W Accent Lighting - Choose From Any Color in the Light Spectrum
- Back Lit Molded Dash Controller - Enables User to Select Mode, Accent Color, Adaptive Mode, and Select Between 2 User Presets
- 2 User Presets - Preset Both Beam Pattern Mode & Accent Lighting Colors
- Multiple Mounting Locations; Traditional Side Mounting or Underside Low-Profile Mount
- Patent-Pending Technology

DIMENSIONS

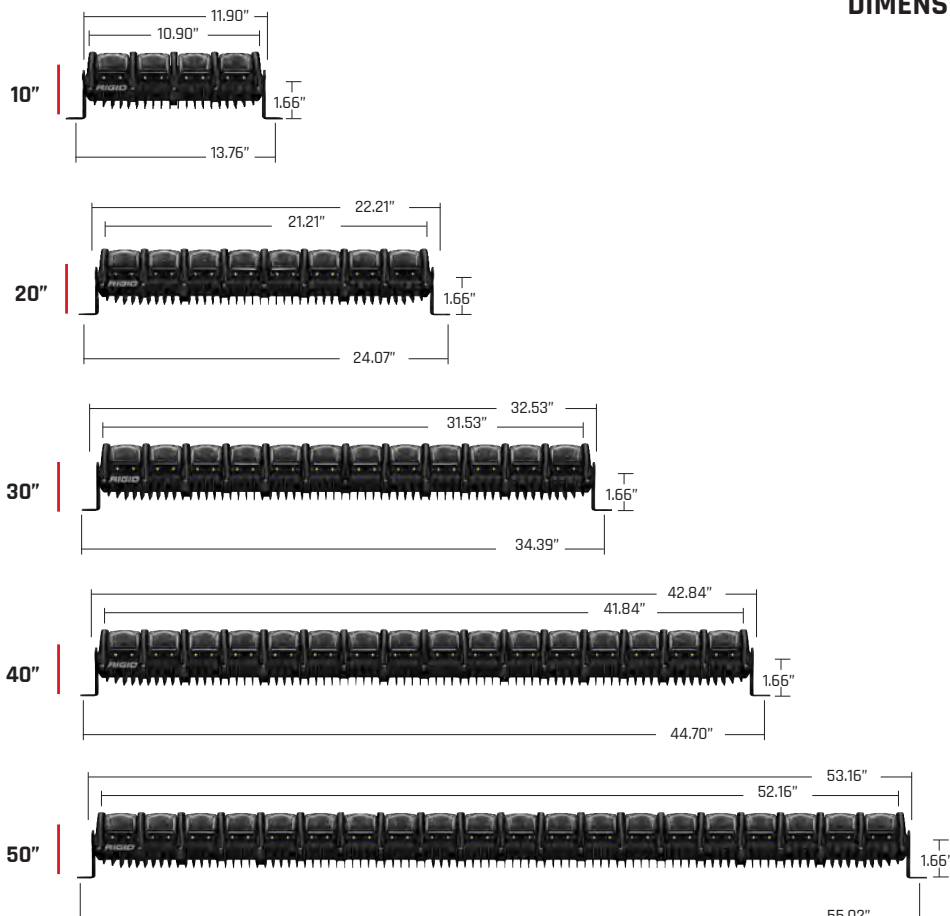

BEAM PATTERNS
THAT CAN
ACTIVELY ADJUST
WITH CHANGING
CONDITIONS



8 BEAM PATTERN MODES

Adapt offers 8 selectable beam patterns that range from broad short-distance lighting to highly focused long-distance lighting in a single fixture. It also includes RIGID's new Active View Technology, which allows the beam pattern to actively adjust with vehicle speed. There are no moving parts within the Adapt. Instead, RIGID uses advanced LED technology and combines it with patented new optics to create a revolutionary lighting solution that can Adapt with changing conditions.

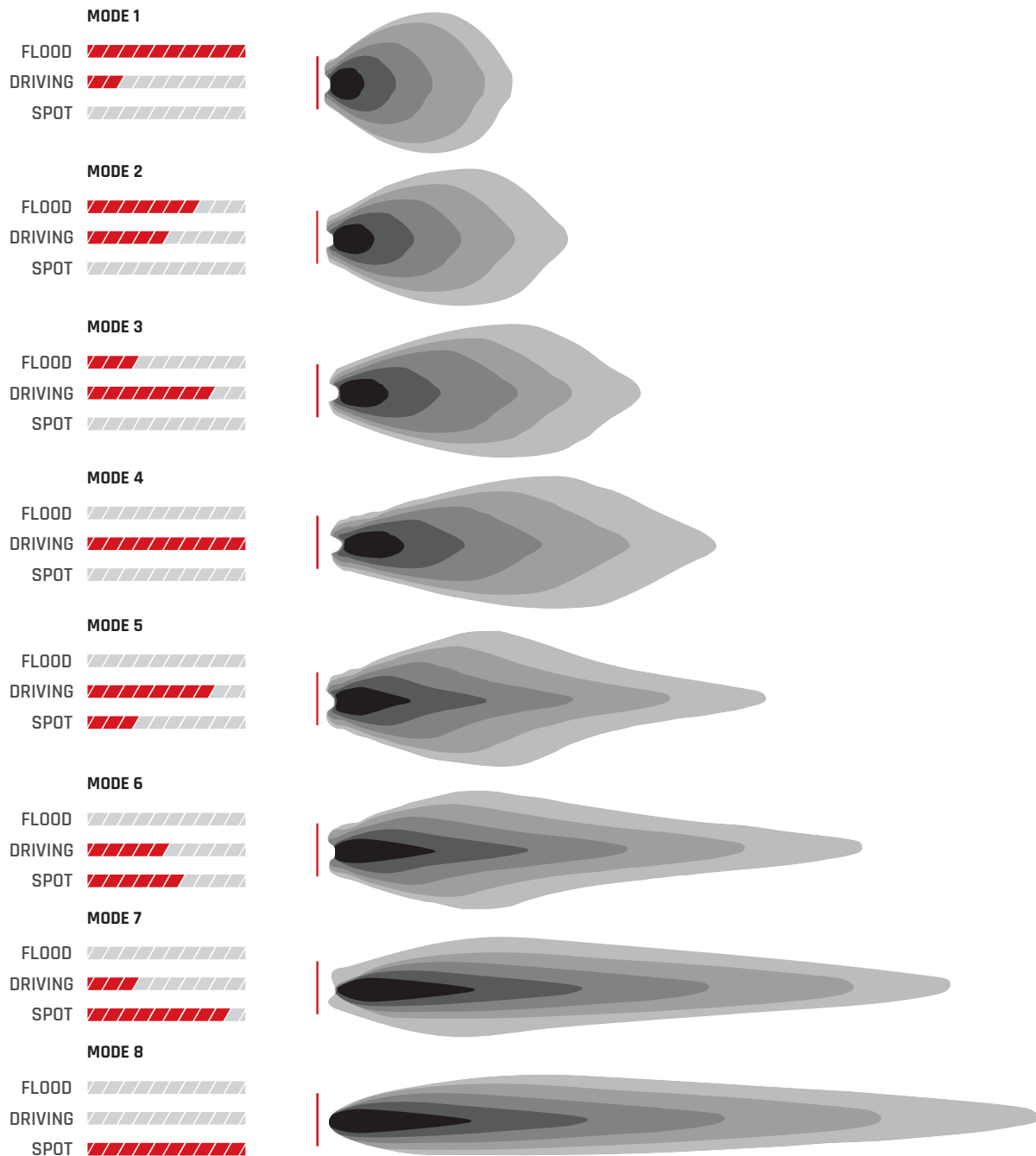

ALL ADAPT
LIGHT BARS
INCLUDE BUILT IN
RGB-W ACCENT
LIGHTING

PART NUMBERS



Size	PART NO.
10"	21041
20"	22041
30"	23041
40"	24041
50"	25041



BUILT IN RGB-W ACCENT LIGHTING

Adapt has built-in accent lighting that can be set to ANY color in the light spectrum, including white, for a custom look around town.



LIGHTS COME WITH

- Mounting Hardware
- Black Powder Coated, L-Shape Brackets
- Harness & Under Dash Control Box
- Keypad & Dash Switch

- SOLD SEPARATELY
- Underside Low-Profile Mounts

D-SS[®]

One of RIGID's most versatile, compact lighting solutions just got better with the D-SS, Dually Side Shooter LED pod. Perfect for any application that requires a wide spread beam, including A-Pillars, Fog Lights, and motorcycle applications. The D-SS pod incorporates the same powerful optics and legendary LED technology as RIGID's popular D-Series lights but with the added benefit of additional LEDs aimed to the side for a much broader beam. The D-SS fixtures boast 120-degrees of horizontal lighting coverage when used in pairs or when used in the single light applications. The main forward-facing LEDs are available with RIGID's advanced Flood, Spot, or Driving optics, so there's a D-SS lighting solution for nearly any application. The D-SS LED lights are available in pairs with three side-shooting LEDs on one side of each fixture, or in single applications with a pair of side-shooting LEDs on both sides of the fixture. Only RIGID provides a broad, powerful lighting solution in such a compact package.

RIGID's D-SS lights are also available with a durable white finish. Though suitable for marine applications, RIGID's white lighting products are perfect for use anywhere an alternative to black is desired. The distinctive white is a durable UV-resistant powder coated finish with an additional chromate conversion coating for superior corrosion resistance. They feature the same legendary lighting technology and superior build quality as the rest of RIGID's lighting products, providing reliable and efficient lighting on demand.

**120° LIGHT
COVERAGE**





FEATURES

- Up to 50,000+ Hour Lifespan
- 9-36 V DC
- Durable UV Polyester Powder Coat
- GORE® Pressure Equalizing Vent
- Harness & Switch Included
- High-Grade Aluminum Alloy Heatsink
- Integrated Thermal Management System
- Impact Resistant Polycarbonate Lens
- IP68 Compliant – Dust / Water Ingress
- Mounting Brackets Included
- Over / Under Voltage Protection
- Operating Temp -40° F ~ +145° F / -40° C ~ +60° C
- Protected Against RFI / EMI
- Patented Technology
- Reverse Polarity Protection
- RoHS Compliant
- SAE J575 Compliant – Shock / Vibration
- Waterproof Deutsch Connector

DIMENSIONS & MOUNTS



SURFACE MOUNT

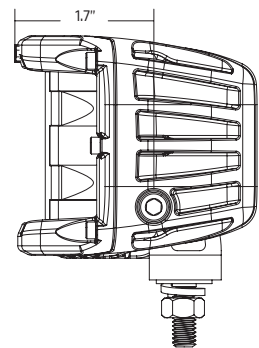
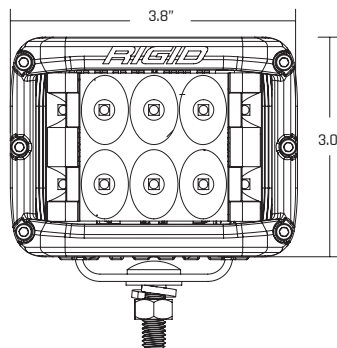

WHAT BEAM
PATTERN WILL
SUIT MY NEEDS
THE BEST?



BEAM PATTERNS

Our custom designed graphs are intended to illustrate the beam patterns that our optics produce. First, consider what type of application the light is needed for and then choose what beam pattern best suits your needs. Each beam pattern varies depending on the optic or optic combination you choose. Once you know which beam pattern best suits your needs, refer to the specifications table (A, B, C) to determine how much LUX output you need and which product will best suit your application.

SINGLES

HYBRID FLOOD

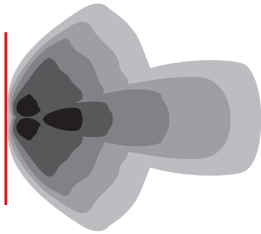

HYBRID SPOT

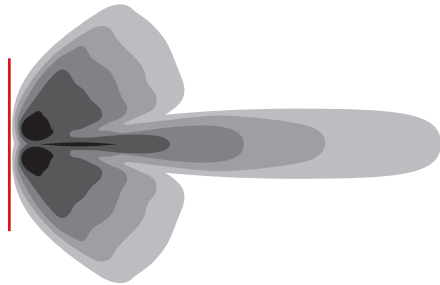

SPECTER DRIVING

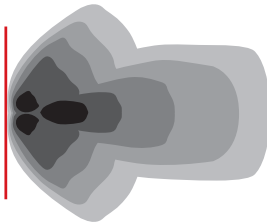

PAIRS

HYBRID FLOOD

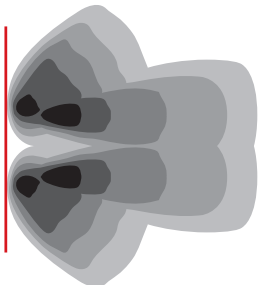

HYBRID SPOT

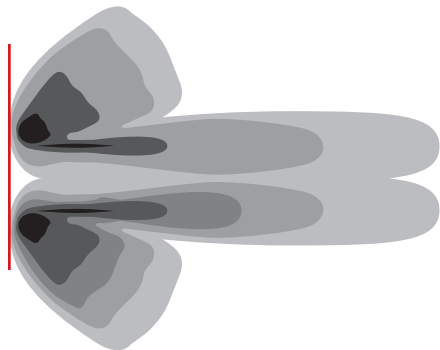

SPECTER DRIVING

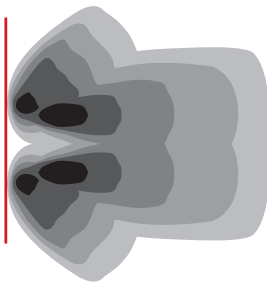

HOW MUCH
OUTPUT DO
I NEED?

A = LUX AT 10 METERS
B = BEAM DISTANCE (m) WITH 1 LUX
C = BEAM DISTANCE (m) WITH .25 LUX

SINGLES

SINGLES / SPECIFICATIONS

	MOUNT	BLACK SINGLE	WHITE SINGLE	WT. (LBS.)	WATTS	AMP DRAW @14VDC	LEDs	*RAW LUMENS	A	B	C	**PEAK BEAM INTENSITY(cd)
HYBRID FLOOD	SM	26111	86211	1.5	28	2	8	2793	41	64	124	4056
HYBRID SPOT	SM	26121	86121	1.5	28	2	8	2793	551	235	470	55128
SPECTER DRIVING	SM	26131	86131	1.5	37	2.6	10	3675	145	121	241	14528

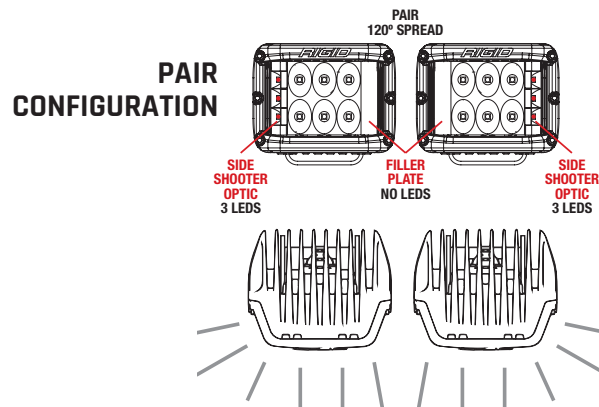
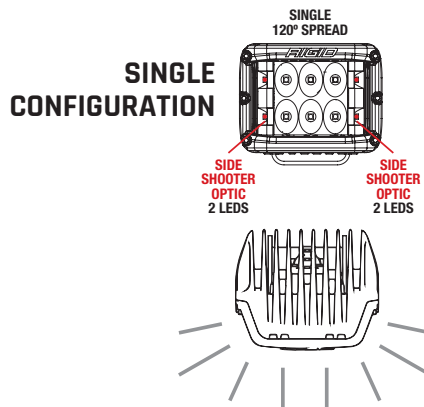

PAIRS

SPECIFICATIONS ARE DISPLAYED PER SINGLE LIGHT

PAIRS / SPECIFICATIONS

	MOUNT	BLACK PAIR	WHITE PAIR	WT. (LBS.)	WATTS	AMP DRAW @14VDC	LEDs	*RAW LUMENS	A	B	C	**PEAK BEAM INTENSITY(cd)
HYBRID FLOOD	SM	26211	86211	1.5	24	1.7	7	2425	42	65	130	4241
HYBRID SPOT	SM	26221	86221	1.5	24	1.7	7	2425	520	228	456	52003
SPECTER DRIVING	SM	26231	86231	1.5	33	2.3	9	3308	181	134	269	18066

* Raw Lumens is based on LED manufacturer specifications.**Distance with .25 lux and Peak Beam Intensity are tested using ANSI/NEMA FL standards.
(SM) = Surface Mount



LIGHTS COME WITH

- Lights come as Singles or Pairs
- Mounting Hardware
- Stainless Steel, U-Shape Bracket

BLACK HOUSING ONLY

- Harness w/Switch
- Deutsch Connector

WHITE HOUSING ONLY

- 3ft 2-Wire Open Leads, No Connector
- Harness Sold Separately
 - Singles PN 40194
 - Pairs PN 40196

RADIANCE POD™

Rigid's innovative Radiance line continues to expand with the Radiance Pod, a unique lighting solution that offers Rigid's legendary quality at a level everyone can attain. A compact cube similar to Rigid's popular D-Series, the Radiance Pod features independently controlled back-lighting that is available in white, amber, green, red, or blue. The Radiance Pod is built with a rugged aluminum alloy housing to protect the three powerful LEDs inside, while a black exposed circuit board is visible through the durable polycarbonate lens for a unique industrial look. The Radiance Pod is sold in pairs and includes mounting brackets suitable for attachment to any flat surface.



**INDEPENDENTLY
CONTROLLED
BACK-LIGHTING**

Consult your Rigid Industries' installation manual, the Rigid Industries' website and any local, state and federal laws, rules and regulations to determine whether your particular application/installation is authorized for use on a public highway.



FEATURES

- 50,000+ Hour Lifespan
- 10-15 V DC
- Durable UV Polyester Powder Coat
- GORE® Pressure Equalizing Vent
- Harness (Sold Separately)
- High-Grade Aluminum Alloy Heatsink
- Integrated Thermal Management System
- Impact Resistant Polycarbonate Lens
- IP68 Compliant - Dust / Water Ingress
- Mounting Brackets Included
- Over / Under Voltage Protection
- Operating Temp -40° F ~ +145° F / -40° C ~ +60° C
- Protected Against RFI / EMI
- Patented Technology
- Reverse Polarity Protection
- RoHS Compliant
- SAE J575 Compliant - Shock / Vibration
- D-Series Construction & Durability
- Complete Multi-Switch Wiring Harness Available (Sold Separately - Part Number 40300)
- Independently Controlled Back-Lighting Available in White, Amber, Red, Blue or Green
- Dedicated Wire to Run Back-Lighting without Primary LEDs
- Stainless Steel Mounting Brackets
- Black Exposed Circuit Board
- Patent-Pending Technology

DIMENSIONS



SURFACE MOUNT

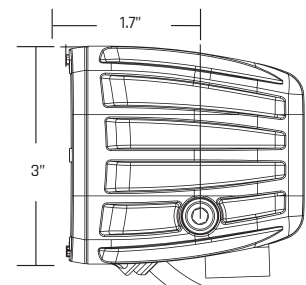
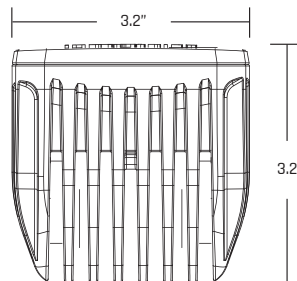

Complete Multi-Switch Wiring Harness Available
Sold Separately - PN 40300



WHAT BEAM
PATTERN WILL
SUIT MY NEEDS
THE BEST?



BEAM PATTERNS

Our custom designed graphs are intended to illustrate the beam patterns that our optics produce. First, consider what type of application the light is needed for and then choose what beam pattern best suits your needs. Each beam pattern varies depending on the optic or optic combination you choose. Once you know which beam pattern best suits your needs, refer to the specifications table (A, B, C) to determine how much LUX output you need and which product will best suit your application.

BROAD OPTIC

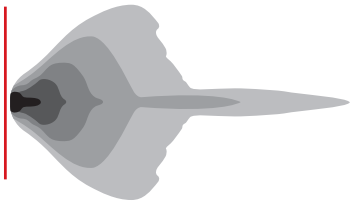

**HOW MUCH
OUTPUT DO
I NEED?**

A = LUX AT 10 METERS
B = BEAM DISTANCE (m) WITH 1 LUX
C = BEAM DISTANCE (m) WITH .25 LUX

SPECIFICATIONS



	MOUNT	BLACK PAIR	WT. (LBS.)	WATTS	AMP DRAW @ 14V	LEDs	*RAW LUMENS	A	B	C	**PEAK BEAM INTENSITY(cd)
WHITE BACK LIGHT	SM	20200	1.5	15	1	3	900	125	112	224	12456
BLUE BACK LIGHT	SM	20201	1.5	15	1	3	900	125	112	224	12456
RED BACK LIGHT	SM	20202	1.5	15	1	3	900	125	112	224	12456
GREEN BACK LIGHT	SM	20203	1.5	15	1	3	900	125	112	224	12456
AMBER BACK LIGHT	SM	20204	1.5	15	1	3	900	125	112	224	12456

* Raw Lumens is based on LED manufacturer specifications.**Distance with .25 lux and Peak Beam Intensity are tested using ANSI/NEMA FL standards.



LIGHTS COME WITH

- Mounting Hardware
- Stainless Steel, U-Shape Brackets
- Open Leads, No Connector

HARNESS SOLD SEPARATELY

- Complete Multi-Switch Wiring Harness - PN 40300

RADIANCE™

The all-new RIGID Industries Radiance light bar is the perfect solution for those who want RIGID's legendary quality at a level everyone can attain. The Rigid Industries Radiance light bar is built with the same high-grade aluminum alloy housing as our legendary E-Series, but that's where the visual similarities end. Inside, the Rigid Industries Radiance light bar is feature-packed, with a black exposed circuit board, optimized forward projecting optics and back-lighting available in white, amber, red, blue or green. Large back-lit Rigid branding plates further add to the unique look of the Rigid Industries Radiance light bar. The Rigid Industries Radiance light bar is for the customer who wants a truly custom look that only Rigid can provide. Available in 10" – 50" lengths, the Rigid Industries Radiance light bar is the perfect entry into Rigid Industries' performance LED lighting.



**BACK-LIGHTING
AVAILABLE
IN 5 COLORS**



"Consult your Rigid Industries' installation manual, the Rigid Industries' website and any local, state and federal laws, rules and regulations to determine whether your particular application/installation is authorized for use on a public highway."



FEATURES

- 50,000+ Hour Lifespan
- 10-15 V DC
- Durable UV Polyester Powder Coat
- GORE® Pressure Equalizing Vent
- Harness (Sold Separately)
- High-Grade Aluminum Alloy Heatsink
- Integrated Thermal Management System
- Impact Resistant Polycarbonate Lens
- IP68 Compliant - Dust / Water Ingress
- Mounting Brackets Included
- Over / Under Voltage Protection
- Operating Temp -40° F ~ +145° F / -40° C ~ +60° C
- Protected Against RFI / EMI
- Patented Technology
- Reverse Polarity Protection
- RoHS Compliant
- SAE J575 Compliant - Shock / Vibration
- E-Series Construction & Durability
- Complete Multi-Switch Wiring Harness Available (Sold Separately - Part Number 40200)
- Independently Controlled Back-Lighting Available in White, Amber, Red, Blue or Green
- Dedicated Wire to Run Back-Lighting without Primary LEDs
- Black Powder Coated Mounting Brackets
- Black Exposed Circuit Board
- Patent-Pending Technology

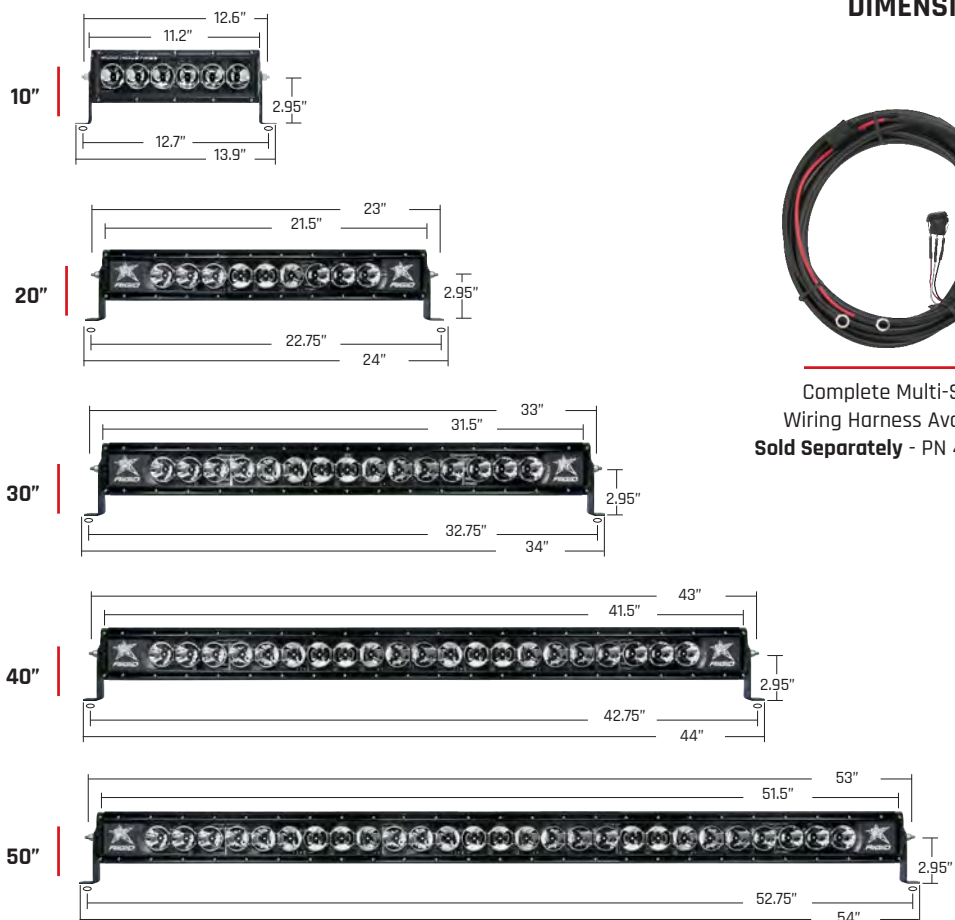

WHAT BEAM
PATTERN WILL
SUIT MY NEEDS
THE BEST?



BEAM PATTERNS

Our custom designed graphs are intended to illustrate the beam patterns that our optics produce. First, consider what type of application the light is needed for and then choose what beam pattern best suits your needs. Each beam pattern varies depending on the optic or optic combination you choose. Once you know which beam pattern best suits your needs, refer to the specifications table (A, B, C) to determine how much LUX output you need and which product will best suit your application.

BROAD SPOT OPTIC

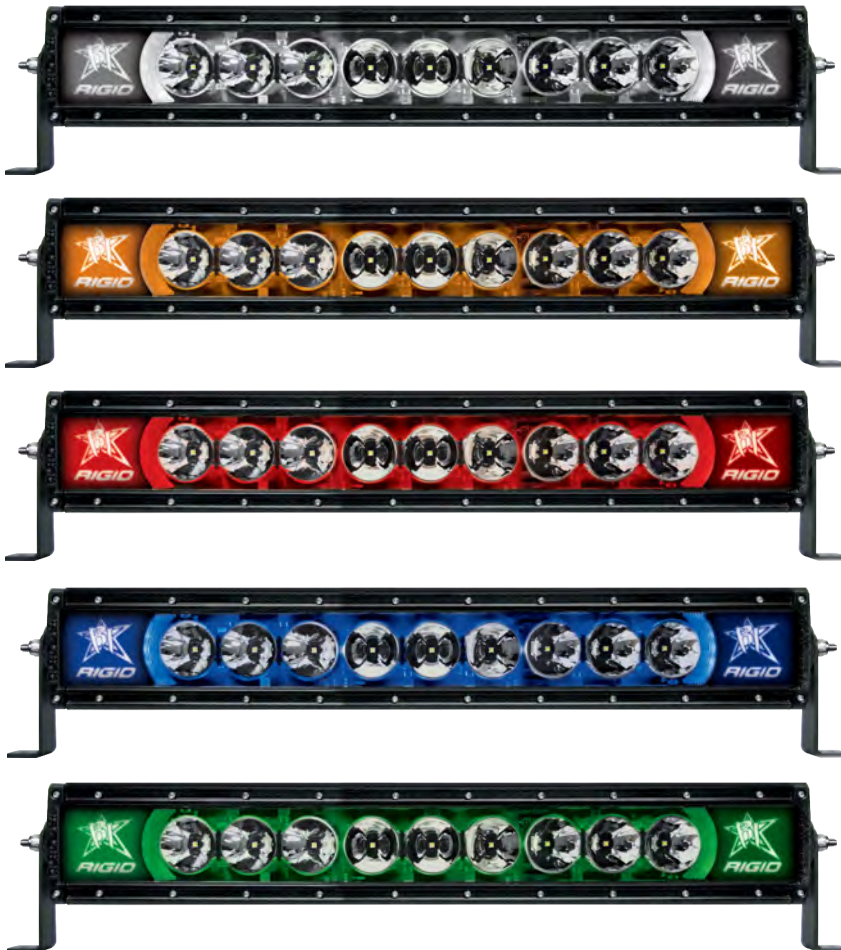
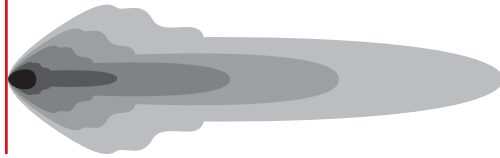

HOW MUCH
OUTPUT DO
I NEED?

A = LUX AT 10 METERS
B = BEAM DISTANCE (m) WITH 1 LUX
C = BEAM DISTANCE (m) WITH .25 LUX

SPECIFICATIONS



	SIZE	BLACK PART NO.	WT (LBS.)	WATTS	AMP DRAW @ 14VDC	LEDs	*RAW LUMENS	A	B	C	**PEAK BEAM INTENSITY(cd)
WHITE BACK LIGHT	10"	21000	5.6	62	4.42	6	3528	906	264	527	86520
	20"	22000	7.65	94	6.69	9	5292	1360	396	791	129780
	30"	23000	10.55	155	11.09	15	8820	2266	659	1318	216300
	40"	24000	13.61	217	15.50	21	12348	3172	923	1846	302820
	50"	25000	16.84	279	19.90	27	15876	4079	1187	2373	389340
BLUE BACK LIGHT	10"	21001	5.6	62	4.42	6	3528	906	264	527	86520
	20"	22001	7.65	94	6.69	9	5292	1360	396	791	129780
	30"	23001	10.55	155	11.09	15	8820	2266	659	1318	216300
	40"	24001	13.61	217	15.50	21	12348	3172	923	1846	302820
	50"	25001	16.84	279	19.90	27	15876	4079	1187	2373	389340
RED BACK LIGHT	10"	21002	5.6	62	4.42	6	3528	906	264	527	86520
	20"	22002	7.65	94	6.69	9	5292	1360	396	791	129780
	30"	23002	10.55	155	11.09	15	8820	2266	659	1318	216300
	40"	24002	13.61	217	15.50	21	12348	3172	923	1846	302820
	50"	25002	16.84	279	19.90	27	15876	4079	1187	2373	389340
GREEN BACK LIGHT	10"	21003	5.6	62	4.42	6	3528	906	264	527	86520
	20"	22003	7.65	94	6.69	9	5292	1360	396	791	129780
	30"	23003	10.55	155	11.09	15	8820	2266	659	1318	216300
	40"	24003	13.61	217	15.50	21	12348	3172	923	1846	302820
	50"	25003	16.84	279	19.90	27	15876	4079	1187	2373	389340
AMBER BACK LIGHT	10"	21004	5.6	62	4.42	6	3528	906	264	527	86520
	20"	22004	7.65	94	6.69	9	5292	1360	396	791	129780
	30"	23004	10.55	155	11.09	15	8820	2266	659	1318	216300
	40"	24004	13.61	217	15.50	21	12348	3172	923	1846	302820
	50"	25004	16.84	279	19.90	27	15876	4079	1187	2373	389340

* Raw Lumens is based on LED manufacturer specifications.**Distance with .25 lux and Peak Beam Intensity are tested using ANSI/NEMA FL standards.



LIGHTS COME WITH

- Mounting Hardware
- Black Powder Coated, L-Shape Brackets
- Open Leads, No Connector
- 2ft Wire Extension (20" - 50")

SOLD SEPARATELY

- Complete Multi-Switch Wiring Harness PN 40200

CHASE™

The RIGID Chase rear facing LED light adds safety and functionality to any UTV, rail, buggy, Jeep, or other off-road application by packing reverse, courtesy, strobe, running (low power), and brake lights (high power) into a single compact package. A halo of powerful colored LEDs in red, amber, or blue around the perimeter of the aluminum housing can be used as a strobe (for racing and chase applications), running light, or third brake light. The center portion of the RIGID Chase functions as a 715 lumen white light suitable for use as a reverse or area light, and there's also a smaller downward-facing courtesy light for illuminating the cargo area. Whether it's used individually or wired in series, the Rigid Chase LED light is packed with features at a great value.



AMBER



BLUE



RED



STROBE,
COURTESY,
REVERSE,
RUNNING & BRAKE
ALL IN ONE

5 MODES



STROBE



COURTESY



REVERSE



RUNNING



BRAKE



FEATURES

- 50,000+ Hour Lifespan
- 10-15 V DC
- Durable UV Polyester Powder Coat
- GORE® Pressure Equalizing Vent
- High-Grade Aluminum Alloy Heatsink
- Integrated Thermal Management System
- Impact Resistant Polycarbonate Lens
- IP66 Compliant - Dust / Water Ingress
- Mounting Brackets Included
- Over / Under Voltage Protection
- Operating Temp -40° F ~ +145° F / -40° C ~ +60° C
- Protected Against RFI / EMI
- Patented Technology
- Reverse Polarity Protection
- RoHS Compliant
- SAE J575 Compliant - Shock / Vibration
- Reverse Light and Courtesy Light
- Halo Features 3 Modes; Strobe, Running, Brake
- 3 Halo Color Options; Amber, Red, & Blue
- Universal 90° Mounting Bracket
- 1.75" - 2.00" Adjustable Tube Mount
- 5ft Multi-Trigger Lead for Versatile Configurations

DIMENSIONS & MOUNTS

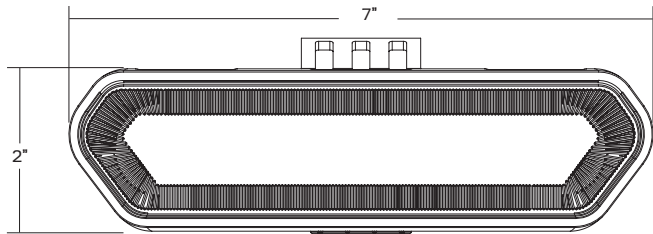

SURFACE MOUNT

Universal 90° Mount Included



TOP FRONT

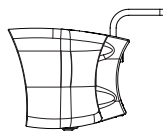

TOP BACK

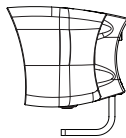

BOTTOM FRONT

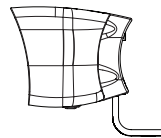

BOTTOM BACK

MOUNTING OPTIONS

ADJUSTABLE TUBE MOUNT

Mount Included

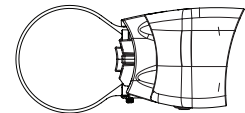

FITS 1.75" - 2" TUBE

COURTESY AND REVERSE BEAM PATTERNS

BEAM PATTERNS

Unlike all of our other lights, the RIGID Chase does not have a forward-projecting light. But, the Chase does include both a courtesy and reverse light among its many features. The custom-designed graphs illustrate these beam patterns below.

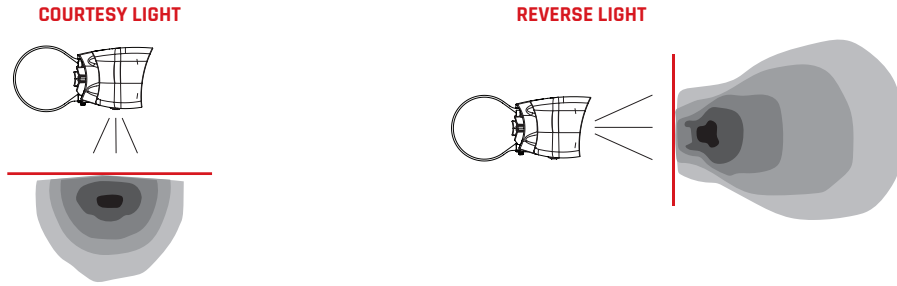

MODES



COURTESY



REVERSE

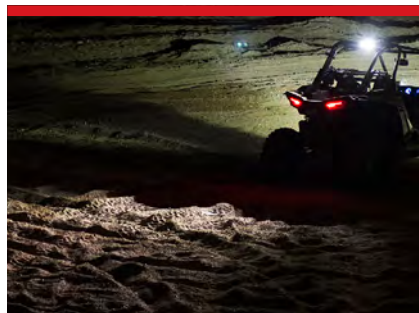
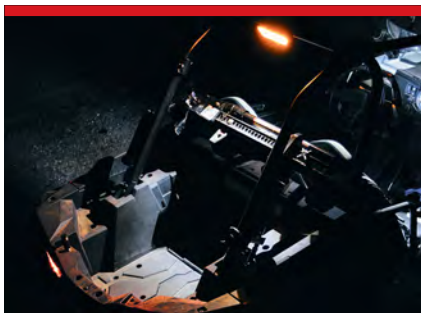

RUNNING



STROBE



BRAKE



CHOOSE YOUR
COLOR OPTION
AMBER, RED
OR BLUE

SPECIFICATIONS



	AMBER	RED	BLUE	MODE	WATTS	AMP DRAW @14VDC	*RAW LUMENS
CHASE	90122	90133	90144	COURTESY LIGHT	4.2	0.3	168
				REVERSE LIGHT	9.8	0.7	715

* Raw Lumens is based on LED manufacturer specifications.

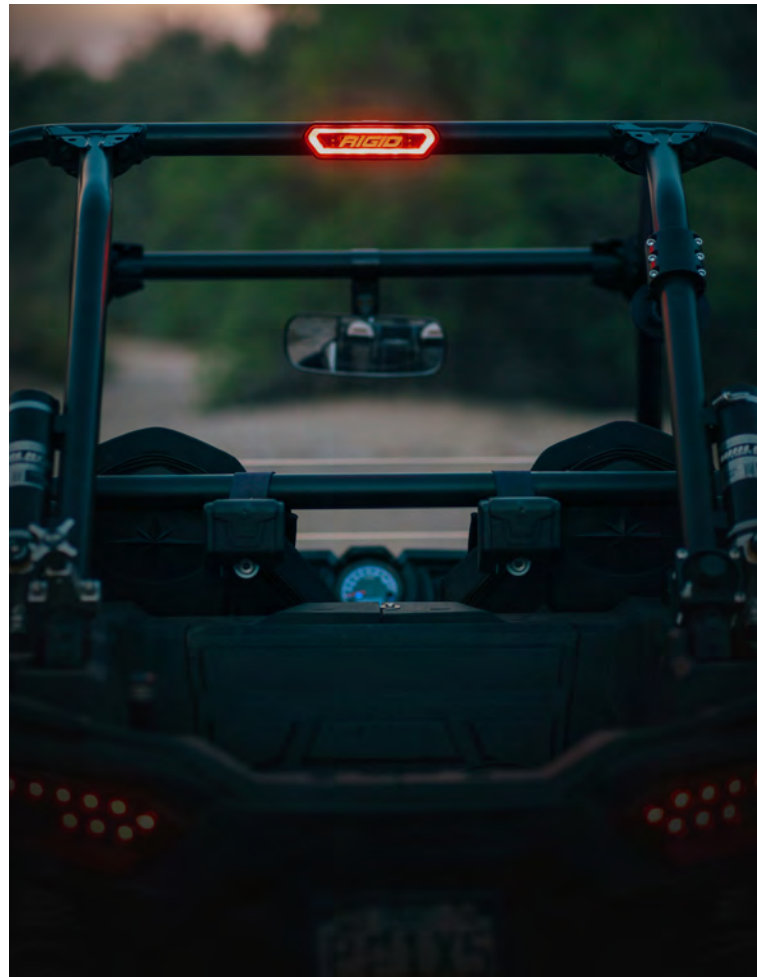

LIGHTS COME WITH

- Mounting Hardware
- Black Powder Coated, L-Shape Bracket
- Black Powder Coated, Adjustable Tube Clamp
- Multi-Trigger Open Leads, No Connector
- 5ft Wire Extension

REFLECT™

The RIGID Reflect is the first LED light that not only illuminates the road ahead, but also allows you to see what's behind. The RIGID Reflect is an advanced LED lighting solution with a fully adjustable side mirror all in one. Though originally developed for UTV and Powersports applications, the Reflect is a great solution for just about any off-road application. The Reflect uses RIGID's patented LED technology and new Side-Shooter optics to provide a wide beam of light for cornering and drifting. For even more versatility, there are also built-in amber LEDs on the outside edge of the fixture that can be used as turn signals, flashers, or even auxiliary running lights. The lights and mirror can be aimed independently, and tube mounting clamps are included to make installation easy. The RIGID Reflect is one more compact, versatile lighting solution that enables off-road enthusiasts to Own the Night™.





FEATURES

- 50,000+ Hour Lifespan
- 10-15 V DC
- GORE® Pressure Equalizing Vent
- High-Grade Aluminum Alloy Heatsink
- Integrated Thermal Management System
- Impact Resistant Polycarbonate Lens
- IP68 Compliant - Dust / Water Ingress
- Over / Under Voltage Protection
- Operating Temp -40° F ~ +145° F / -40° C ~ +60° C
- Protected Against RFI / EMI
- Patented Technology
- Reverse Polarity Protection
- RoHS Compliant
- SAE J575 Compliant - Shock / Vibration
- Light and Mirror Can Be Independently Adjusted
- Side Shooter Optic & Lenticular Lens for Enhanced Beam Width
- Integrated Amber LEDs for use as Running Lights or Turn Signal
- Fully Adjustable 1.75" - 2.00" Tube Mount Included
- Break Away Joint for Damage Prevention
- Convex Mirror for Enhanced Field of Vision
- 3-Wire Open Lead for Convenient Wiring

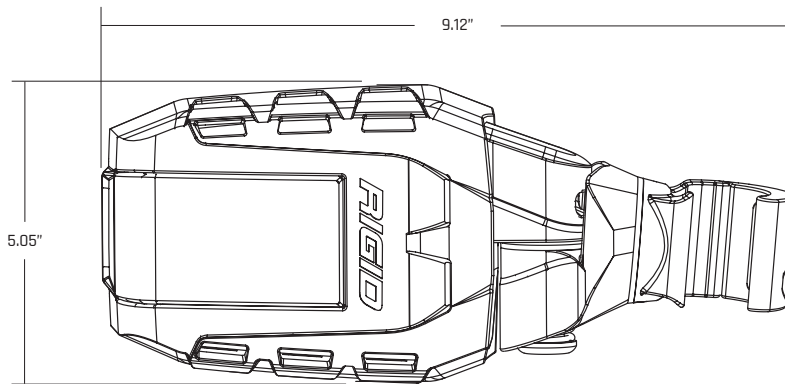

DIMENSIONS

ALL HOUSINGS AVAILABLE IN WHITE



BEAM PATTERNS



HYBRID FLOOD



LIGHTS COME WITH

- Mounting Hardware
- Adjustable Tube Clamp
- 3-Wire Open Leads, No Connector
- Come as Pair (Left Side & Right Side)

Reflect

BLACK PART#

640111

SPECIFICATIONS



IGNITE™

The Rigid Ignite™ is the smallest, most versatile forward projecting light in Rigid Industries' product line! Measuring approximately 1.4" x 1.4" x 2", this flexible light packs 1000 raw lumens using Spot, Flood or Diffused beam patterns; perfect for any application where short range light output is needed. The Ignite utilizes a Go-Pro® style mounting bracket which mates with an array of off the shelf Go-Pro mounts. Due to the wide range of mounting options, the Ignite's applications are almost limitless. The compact and lightweight housing makes the Ignite a great choice for auxiliary lighting on cars and trucks, motorcycles, UTVs, and even marine applications. Low current draw (less than 1 amp) and voltage requirements (7-28 volts) makes the Ignite adaptable to any application. Single light kits include one Ignite, mounting brackets, and related hardware. GoPro Mount Not Included.

RIGID Ignite lights are also available with a durable white finish. Though suitable for marine applications, RIGID's white lighting products are perfect for use anywhere an alternative to black is desired. The distinctive white is a durable UV-resistant powder coated finish with an additional chromate conversion coating for superior corrosion resistance. They feature the same legendary lighting technology and superior build quality as the rest of RIGID's lighting products, providing reliable and efficient lighting on demand.



**UNIVERSAL
GoPro® STYLE
MOUNT
DESIGN**



FEATURES

- 50,000+ Hour Lifespan
- 7-24 V DC
- Durable UV Polyester Powder Coat
- GORE® Pressure Equalizing Vent
- High-Grade Aluminum Alloy Heatsink
- Integrated Thermal Management System
- Impact Resistant Polycarbonate Lens
- IP68 Compliant – Dust / Water Ingress
- Mount Included (Surface Mount Only)
- Over / Under Voltage Protection
- Operating Temp -40° F ~ +145° F / -40° C ~ +60° C
- Protected Against RFI / EMI
- Patented Technology
- Reverse Polarity Protection
- RoHS Compliant
- SAE J575 Compliant – Shock / Vibration
- Surface Mount; Mates To Any Go-Pro® Case Mount
- Universal Go-Pro-Style Mount Design
- 2-Wire Open Lead for any 7-24 V DC Application

DIMENSIONS & MOUNTS

ALL HOUSINGS AVAILABLE IN WHITE



SURFACE MOUNT

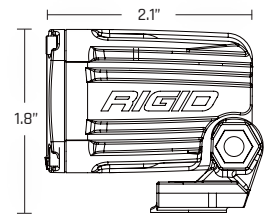
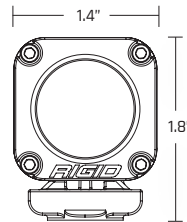

FLUSH MOUNT

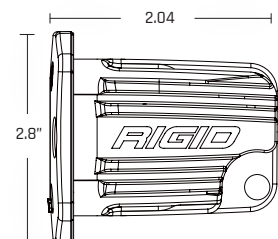
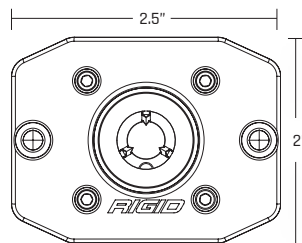

WHAT BEAM
PATTERN WILL
SUIT MY NEEDS
THE BEST?



BEAM PATTERNS

Our custom designed graphs are intended to illustrate the beam patterns that our optics produce. First, consider what type of application the light is needed for and then choose what beam pattern best suits your needs. Each beam pattern varies depending on the optic or optic combination you choose. Once you know which beam pattern best suits your needs, refer to the specifications table (A, B, C) to determine how much LUX output you need and which product will best suit your application.

HYBRID DIFFUSED

Flood optic behind diffused lens

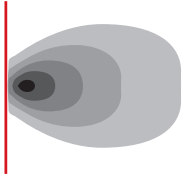

HYBRID FLOOD

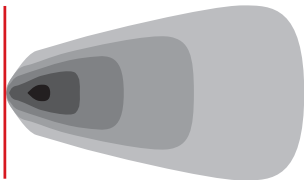

HYBRID SPOT

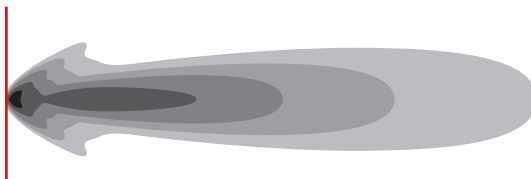

HOW MUCH
OUTPUT DO
I NEED?

A = LUX AT 10 METERS
B = BEAM DISTANCE (m) WITH 1 LUX
C = BEAM DISTANCE (m) WITH .25 LUX

SPECIFICATIONS



	MOUNT	BLACK SINGLE	BLACK PAIR	WHITE SINGLE	WHITE PAIR	WT. (LBS.)	WATTS	AMP DRAW @14VDC	LEDs	*RAW LUMENS	A	B	C	**PEAK BEAM INTENSITY(cd)
HYBRID DIFFUSED	SM	20531	-	60531	-	3.8	12	0.85	1	1000	9	29	60	885
	FM	20631	-	60631	-	3.8	12	0.85	1	1000	9	29	60	885
HYBRID FLOOD	SM	20521	-	60521	-	3.8	12	0.85	1	1000	18	42	80	1786
	FM	20621	-	60621	-	3.8	12	0.85	1	1000	18	42	80	1786
HYBRID SPOT	SM	20511	-	60511	-	3.8	12	0.85	1	1000	139	118	236	13939
	FM	20611	-	60611	-	3.8	12	0.85	1	1000	139	118	236	13939

* Raw Lumens is based on LED manufacturer specifications.**Distance with .25 lux and Peak Beam Intensity are tested using ANSI/NEMA FL standards.
(SM) = Surface Mount, (FM) = Flush Mount



MATES
WITH AN
ARRAY
OF MOUNTS



LIGHTS COME WITH

- Mounting Hardware
- Black or White Mount (Surface Only)
- 2-Wire Open Leads, No Connector

MIDNIGHT EDITION™

It's all about stealth with Rigid's new Midnight Optics. Utilizing our exclusive Hybrid Spot Optic with a translucent black enamel coating, our Midnight Optics take the subtle "blacked out" look seriously; from black oxide hardware, to dark grey screen-printed and black embossed logos on the bezel. Midnight Optics enable Rigid to "disappear" during the day while still providing powerful LED technology to light up the night. Midnight Optics are available in E-Series, RDS-Series, SR-Series, and D-Series product lines.



**LEGACY
PRODUCTS
WITH A DARK
TWIST**





FEATURES

- 50,000+ Hour Lifespan
- 9-36 V DC
- Durable UV Polyester Powder Coat
- GORE® Pressure Equalizing Vent
- Harness & Switch Included (Black Housing Only)
- High-Grade Aluminum Alloy Heatsink
- Integrated Thermal Management System
- Impact Resistant Polycarbonate Lens
- IP68 Compliant - Dust / Water Ingress
- Mounting Brackets Included
- Over / Under Voltage Protection
- Operating Temp -40° F - +145° F / -40° C - +60° C
- Protected Against RFI / EMI
- Patented Technology
- Reverse Polarity Protection
- RoHS Compliant
- SAE J575 Compliant - Shock / Vibration
- Waterproof Deutsch Connector (Some Sizes Excluded)
- Translucent Black Enamel on our Patented Hybrid Spot Optics
- All Black Assembly Hardware
- Special Black Polymer Coated Circuit Board
- Available in RDS-Series, E-Series, SR-Series and D-Series Lights



DIMENSIONS



FOR DIMENSIONS,
REFER TO THE
FOLLOWING SERIES

RDS-Series
E-Series
SR-Series
D-Series

**MIDNIGHT
EDITION
D-SERIES
FLUSH MOUNT**



**MIDNIGHT
EDITION
D-SERIES
SURFACE MOUNT**



MIDNIGHT EDITION RDS-SERIES



MIDNIGHT EDITION E-SERIES



MIDNIGHT EDITION SR-SERIES



WHAT BEAM
PATTERN WILL
SUIT MY NEEDS
THE BEST?



BEAM PATTERNS

Our custom designed graphs are intended to illustrate the beam patterns that our optics produce. First, consider what type of application the light is needed for and then choose what beam pattern best suits your needs. Each beam pattern varies depending on the optic or optic combination you choose. Once you know which beam pattern best suits your needs, refer to the specifications table (A, B, C) to determine how much LUX output you need and which product will best suit your application.

HYBRID SPOT BLACK OPTIC For E-Series, SR-Series, & D-Series

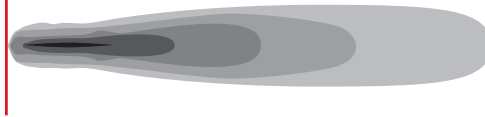
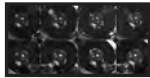

BEAM PATTERNS & RDS PATENTED TECHNOLOGY

The RDS Output Technology™ (U.S. Patent No. D713,574 & U.S. Patent No. 6,986,593) developed by Rigid Industries' engineers is so revolutionary that it required a new way to measure projected light:

Continuous Arc Intensity™

(CAI) is the new way to measure intensity. Since the array of LEDs are not pointing in the same direction, the SAE methodology to measure intensity does not apply. We still measure intensity, but it is spread over an arc at a constant intensity.

Continuous Arc Width™

(CAW) is the width of continuous intensity as shown in the CAI. This is measured in degrees of light projected. For example, the 54" light bar has a 46° beam pattern.

Continuous Arc Distance™

(CAD) is the distance using SAE methodology to measure .25 lux as max beam distance. The difference? "Arc Distance" is measured over the entire width of the CAI, not just the center of the beam.

HYBRID SPOT BLACK OPTIC For RDS Series

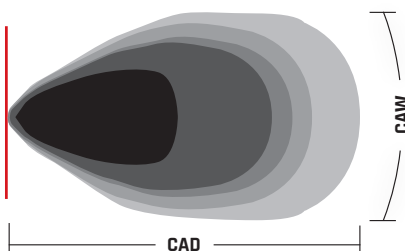
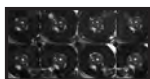

HOW MUCH
OUTPUT DO
I NEED?

A = LUX AT 10 METERS
B = BEAM DISTANCE (m) WITH 1 LUX
C = BEAM DISTANCE (m) WITH .25 LUX

SPECIFICATIONS



	SIZE	BLACK PART NO.	PAIR PART NO.	WT. (LBS.)	WATTS	AMP DRAW @14VDC	LEDs	*RAW LUMENS	A	B	C	**PEAK BEAM INTENSITY(cd)
D-SERIES HYBRID SPOT BLACK OPTIC	D-Series Surface Mount	20121BLK	20221BLK	1.10	15.8	1.1	4	1568	512	226	453	51245
	D-Series Flush Mount	21121BLK	21221BLK	1.10	15.8	1.1	4	1568	512	226	453	51245
E-SERIES HYBRID SPOT BLACK OPTIC	4"	104212BLK	-	1.90	30	2.17	8	3000	794	282	564	79437
	6"	106212BLK	-	2.35	45	3.26	12	4500	1251	354	707	125125
	10"	110212BLK	-	3.45	65	4.71	20	5740	1809	425	851	180895
	20"	120212BLK	-	6.15	110	7.97	40	9200	2524	502	1005	252395
	30"	130212BLK	-	8.85	165	11.96	60	13800	3110	558	1115	311025
	40"	140212BLK	-	11.55	220	15.94	80	18400	4841	696	1391	484055
	50"	150212BLK	-	14.25	275	19.93	100	23000	5842	764	1529	584155
SR-SERIES HYBRID SPOT BLACK OPTIC	6"	906212BLK	-	1.78	24	1.70	6	2250	577	240	480	57760
	10"	910212BLK	-	2.50	36	2.60	10	3750	1019	319	638	101910
	20"	920212BLK	-	5.43	76	5.50	20	7500	1260	355	709	126000
	30"	930212BLK	-	8.15	117	8.50	30	11250	1584	398	795	158400
	40"	940212BLK	-	10.87	163	11.80	40	15000	2347	484	969	234720
	50"	950212BLK	-	13.59	200	14.50	50	18750	2930	541	1083	293040

SPECIFICATIONS



	SIZE	BLACK PART NO.	WT. (LBS.)	WATTS	AMP DRAW @14VDC	LEDs	*RAW LUMENS	CAI (CANDELA)	CAW (DEGREES)	CAD (METERS)
RDS-SERIES HYBRID SPOT BLACK OPTIC	20"	88221BLK	6.6	150	10.87	40	10460	245000	26.7	989.9
	30"	88321BLK	9.2	225	16.30	60	15690	321000	32.6	1133.1
	40"	88421BLK	12	300	21.74	80	20920	325000	38.4	1140.2
	50"	88521BLK	18.25	375	27.17	100	26150	364000	44.3	1206.6
	54"	88621BLK	20	405	29.35	108	28242	365000	46.6	1208.3

* Raw Lumens is based on LED manufacturer specifications.**Distance with .25 lux and Peak Beam Intensity are tested using ANSI/NEMA FL standards.



LIGHTS COME WITH

- See RDS-SERIES
- See E-SERIES
- See SR-SERIES
- See D-SERIES

RIGID INDUSTRIES CAPTURE[®]

The Rigid Industries Capture[®] is the world's only LED light with an integrated GoPro[®] charging system. The Capture combines a powerful light source with a docking station for GoPro[®] Hero 3+ or 4. High and low light output options provide just the right amount of light for any filming situation. The Capture also features an optimized light output and beam pattern for the GoPro[®] camera's field of view area with Rigid's patented radius housing and a lenticular lens design. The custom high quality Carling[®] switches provide a solid feel and clean look in your vehicle, while the amber lens covers will help your vision and video in adverse conditions. The Capture enables you to record your favorite on- or off-road excursions day or night.

LIGHT COMES WITH

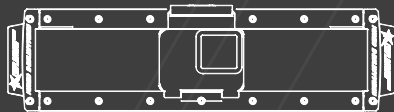

GoPro[®] Not Included.

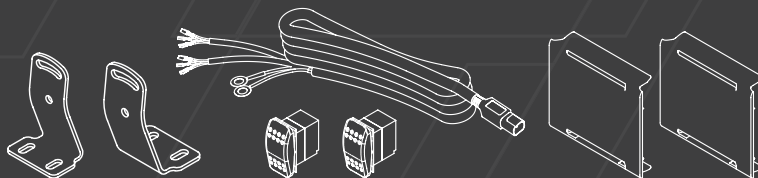

**RECORD.
REVEAL.
RELIVE.[™]**



FEATURES

- 50,000+ Hour Lifespan
- 9-36 V DC
- Durable UV Polyester Powder Coat
- GORE® Pressure Equalizing Vent
- Harness & Switch
- High-Grade Aluminum Alloy Heatsink
- Integrated Thermal Management System
- Impact Resistant Polycarbonate Lens
- IP68 Compliant – Dust / Water Ingress
- Mounting Brackets Included
- Over / Under Voltage Protection
- Operating Temp -40° F ~ +145° F / -40° C ~ +60° C
- Protected Against RFI / EMI
- Patented Technology
- Reverse Polarity Protection
- RoHS Compliant
- SAE J575 Compliant – Shock / Vibration
- Waterproof Deutsch Connector (Black Housing Only)

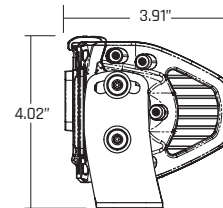
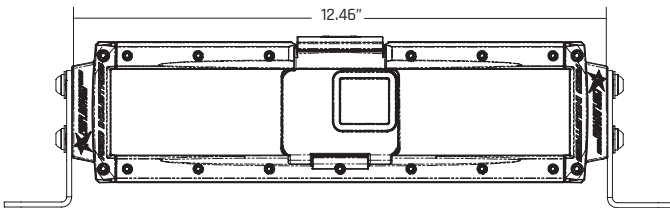

DIMENSIONS

ALL HOUSINGS AVAILABLE IN WHITE



LIGHTS COME WITH

- Mounting Hardware
- Wiring Harness
- 2 Carling Switches
- 2 Carling Switch Bezels
- 2 - 4" Amber Light Covers
- GoPro® NOT INCLUDED

BLACK HOUSING ONLY

- 2 Black Powder Coated, L-Shape Brackets

WHITE HOUSING ONLY

- 2 Stainless Steel, L-Shape Brackets

BEAM PATTERN

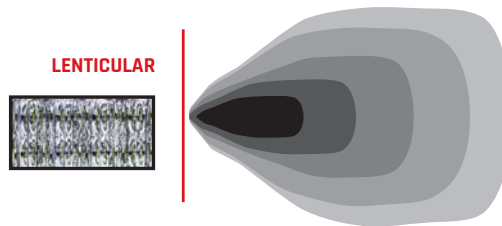

SPECIFICATIONS



A = LUX AT 10 METERS
 B = BEAM DISTANCE (m) WITH 1 LUX
 C = BEAM DISTANCE (m) WITH .25 LUX

	BLACK	WHITE	MODE	LEDS	WATTS	AMP DRAW @ 14VDC	*RAW LUMENS	A	B	C	**PEAK BEAM INTENSITY(CD)
Capture	88100	88103	HIGH	16	63	4.38	5880	82	91	181	8184
			LOW	16	13	.90	1176	24	49	98	2379



Made to be used with GoPro® Hero 3+ or 4 camera. GoPro® Not included.

* Raw Lumens is based on LED manufacturer specifications. **Distance with .25 lux and Peak Beam Intensity are tested using ANSI/NEMA FL standards.

RDS-SERIES®

Rigid revolutionized the lighting industry with the introduction of the RDS-Series. By taking an E-Series light bar and treating it to a gentle arc, the patented RDS-Series provides a sleek, integrated look with the curved windshields and bumpers on today's trucks and SUVs. The curve is for more than just looks, it is also functional: the arc of the RDS-Series light bars provides a wider spread of LED light, providing unmatched lighting coverage with a single light bar.

RIGID's RDS-Series lights are also available with a durable white finish. Though suitable for marine applications, RIGID's white lighting products are perfect for use anywhere an alternative to black is desired. The distinctive white is a durable UV-resistant powder coated finish with an additional chromate conversion coating for superior corrosion resistance. They feature the same legendary lighting technology and superior build quality as the rest of RIGID's lighting products, providing reliable and efficient lighting on demand.



**CURVE YOUR
EXCITEMENT.**





FEATURES

- 50,000+ Hour Lifespan
- 9-36 V DC
- Durable UV Polyester Powder Coat
- GORE® Pressure Equalizing Vent
- Harness & Switch Included (Exclusions Apply)
- High-Grade Aluminum Alloy Heatsink
- Integrated Thermal Management System
- Impact Resistant Polycarbonate Lens
- IP68 Compliant – Dust / Water Ingress
- Mounting Brackets Included
- Over / Under Voltage Protection
- Operating Temp -40° F ~ +145° F / -40° C ~ +60° C
- Protected Against RFI / EMI
- Patented Technology
- Reverse Polarity Protection
- RoHS Compliant
- SAE J575 Compliant – Shock / Vibration
- Waterproof Deutsch Connector (Exclusions Apply)

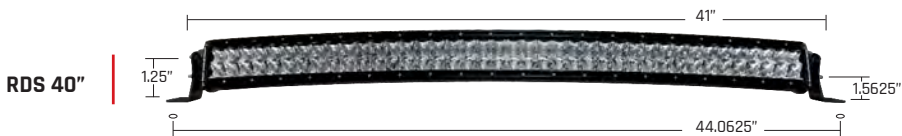
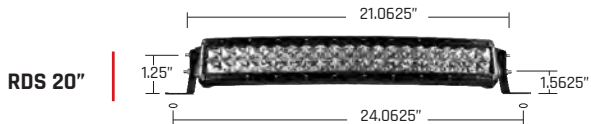

DIMENSIONS

ALL HOUSINGS AVAILABLE IN WHITE



SIDE VIEW

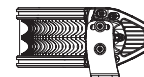

- (20") 4.0625"
- (30") 4.6875"
- (40") 5.6875"
- (50") 6.8125"
- (54") 7.375"

WHAT BEAM
PATTERN WILL
SUIT MY NEEDS
THE BEST?



BEAM PATTERNS & RDS PATENTED TECHNOLOGY

Refer to the specifications table (CAI = candela, CAW = degrees, CAD = meters) to determine how much LUX output you need and which product will best suit your application.



The RDS Output Technology™
(U.S. Patent No. D713,574 & U.S. Patent No. 6,986,593)
developed by Rigid Industries' engineers is so revolutionary that it required a new way to measure projected light:

CAI

Continuous Arc Intensity™

(CAI) is the new way to measure intensity. Since the array of LEDs are not pointing in the same direction, the SAE methodology to measure intensity does not apply. We still measure intensity, but it is spread over an arc at a constant intensity.

CAW

Continuous Arc Width™

(CAW) is the width of continuous intensity as shown in the CAI. This is measured in degrees of light projected. For example, the 54" light bar has a 46° spot beam.

CAD

Continuous Arc Distance™

(CAD) is the distance using SAE methodology to measure .25 lux as max beam distance. The difference? "Arc Distance" is measured over the entire width of the CAI, not just the center of the beam.

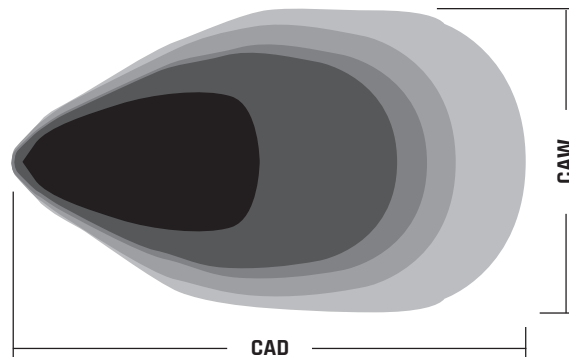

**HOW MUCH
OUTPUT DO
I NEED?**

A = LUX AT 10 METERS
B = BEAM DISTANCE (m) WITH 1 LUX
C = BEAM DISTANCE (m) WITH .25 LUX

SPECIFICATIONS



**HYBRID
SPOT**

SIZE	BLACK PART NO.	WHITE PART NO.	WT (LBS.)	WATTS	AMP DRAW @ 14VDC	LEDs	*RAW LUMENS	CAI (CANDELA)	CAW (DEGREES)	CAD (METERS)
20"	88221	87221	6.6	150	10.87	40	10460	245000	26.7	989.9
30"	88321	87321	9.2	225	16.30	60	15690	321000	32.6	1133.1
40"	88421	87421	12	300	21.74	80	20920	325000	38.4	1140.2
50"	88521	87521	18.25	375	27.17	100	26150	364000	44.3	1206.6
54"	88621	87621	20	405	29.35	108	28242	365000	46.6	1208.3

* Raw Lumens is based on LED manufacturer specifications.**Distance with .25 lux and Peak Beam Intensity are tested using ANSI/NEMA FL standards.



LIGHTS COME WITH

- Mounting Hardware
- 3 Wind Isolators (40" & Up)

BLACK HOUSING ONLY

- 2 Black Powder Coated, L-Shape Brackets
- Harness w/Switch
- Deutsch Connector (20" & 30")
- Open Leads, No Connector (40" & Up)

WHITE HOUSING ONLY

- 2 Stainless Steel, L-Shape Brackets
- Open Leads, No Connector
- Harness Sold Separately
 - PN 40193 (20" & 30")
 - PN 40190 (40" & Up)

E-SERIES®

The E-Series is one of Rigid's most versatile, all-around lighting solutions. Available with your choice of Hybrid Optics or Specter Optics, the E-Series features a host of beam options, including Spot, Flood, Driving, Wide, Hyperspot, Diffused, and Combo. These and other innovations make it one of the brightest and most efficient LED light bars on the market. The E-Series was born in off-road, but its versatility makes it well suited for use with power sports, marine, general automotive and even first responder applications.

RIGID's E-Series lights are also available with a durable white finish. Though suitable for marine applications, RIGID's white lighting products are perfect for use anywhere an alternative to black is desired. The distinctive white is a durable UV-resistant powder coated finish with an additional chromate conversion coating for superior corrosion resistance. They feature the same legendary lighting technology and superior build quality as the rest of RIGID's lighting products, providing reliable and efficient lighting on demand.



THE LIGHT
THAT STARTED
IT ALL



FEATURES

- 50,000+ Hour Lifespan
- 9-36 V DC
- Durable UV Polyester Powder Coat
- GORE® Pressure Equalizing Vent
- Harness & Switch Included (Exclusions Apply)
- High-Grade Aluminum Alloy Heatsink
- Integrated Thermal Management System
- Impact Resistant Polycarbonate Lens
- IP68 Compliant – Dust / Water Ingress
- Mounting Brackets Included
- Over / Under Voltage Protection
- Operating Temp -40° F ~ +145° F / -40° C ~ +60° C
- Protected Against RFI / EMI
- Patented Technology
- Reverse Polarity Protection
- RoHS Compliant
- SAE J575 Compliant – Shock / Vibration
- Waterproof Deutsch Connector (Exclusions Apply)

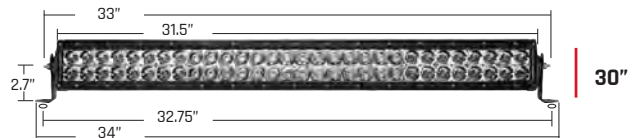
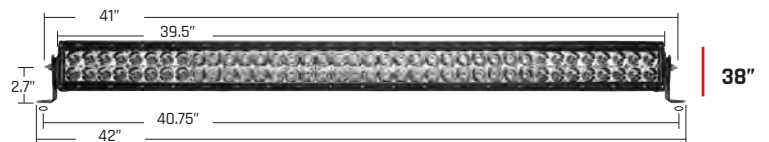
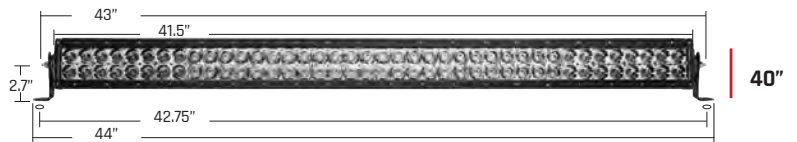
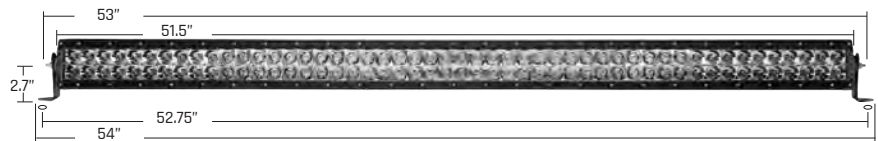
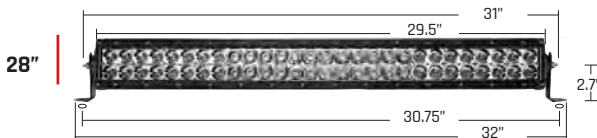
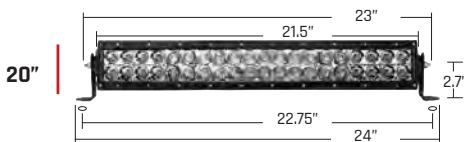
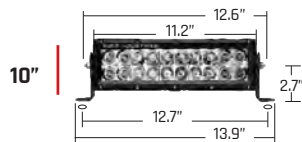
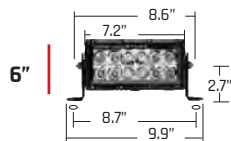
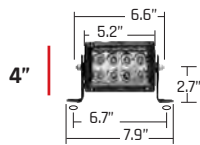

DIMENSIONS

ALL HOUSINGS AVAILABLE IN WHITE



WHAT BEAM
PATTERN WILL
SUIT MY NEEDS
THE BEST?



BEAM PATTERNS

Our custom designed graphs are intended to illustrate the beam patterns that our optics produce. First, consider what type of application the light is needed for and then choose what beam pattern best suits your needs. Each beam pattern varies depending on the optic or optic combination you choose. Once you know which beam pattern best suits your needs, refer to the specifications table (A, B, C) to determine how much LUX output you need and which product will best suit your application.

HYBRID DIFFUSED
Flood optic behind diffused lens

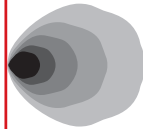

HYBRID FLOOD

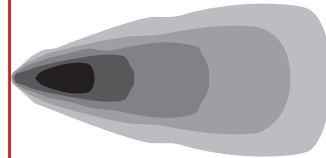

SPECTER DIFFUSED
Driving optic behind diffused lens

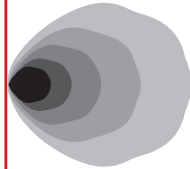

SPECTER DRIVING

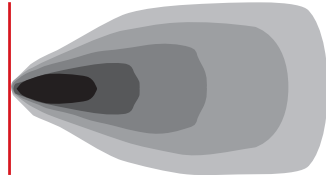

HYBRID SPOT



SPECTER HYPERSPOT



**HYBRID SPOT/
FLOOD COMBO**



**SPECTER DRIVING/
HYPERSPOT COMBO**

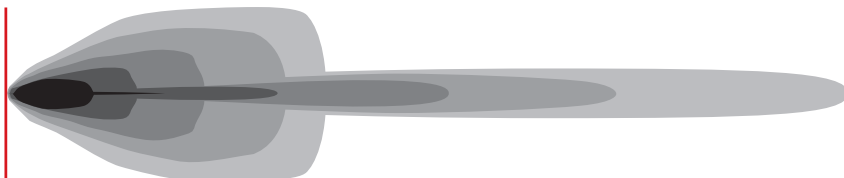

HOW MUCH
OUTPUT DO
I NEED?

A = LUX AT 10 METERS
B = BEAM DISTANCE (m) WITH 1 LUX
C = BEAM DISTANCE (m) WITH .25 LUX

SPECIFICATIONS

OPTIC	SIZE	BLACK PART NO.	WHITE PART NO.	WT (LBS.)	WATTS	AMP DRAW @14VDC	LEDs	*RAW LUMENS	A	B	C	**PEAK BEAM INTENSITY(cd)
HYBRID DIFFUSED	4"	104512	804512	1.9	30	2.17	8	3000	22	47	94	2200
	6"	106512	806512	2.35	45	3.26	12	4500	33	57	115	3300
	10"	110512	810512	3.45	65	4.71	20	5740	50	71	141	5000
SPECTER DIFFUSED	4"	17351	89351	1.9	45	3.26	12	4500	35	59	118	3500
	6"	17551	89551	2.35	67.5	4.89	18	6750	55	74	148	5500
	10"	17851	89851	3.45	75	5.43	30	9000	67	82	164	6748
HYBRID FLOOD	4"	104112	804112	1.9	30	2.17	8	3000	110	105	210	11000
	6"	106112	806112	2.35	45	3.26	12	4500	170	130	261	17000
	10"	110112	810112	3.45	65	4.71	20	5740	260	161	322	26000
	20"	120112	820112	6.15	110	7.97	40	9200	380	195	390	38000
	30"	130112	830112	8.85	165	11.96	60	13800	530	230	460	53000
	40"	140112	840112	11.55	220	15.94	80	18400	840	290	580	84000
SPECTER DRIVING	4"	17361	89361	1.9	45	3.26	12	4500	260	161	322	26000
	6"	17561	89561	2.35	67.5	4.89	18	6750	360	190	379	36000
	10"	17861	89861	3.45	75	5.43	30	9000	482	220	439	48200
	20"	12161	82261	6.15	162	11.8	60	18000	867	294	589	86700
HYBRID SPOT	4"	104212	804212	1.9	30	2.17	8	3000	1111	333	667	111100
	6"	106212	806212	2.35	45	3.26	12	4500	1750	418	837	175000
	10"	110212	810212	3.45	65	4.71	20	5740	2530	503	1006	253000
	20"	120212	820212	6.15	110	7.97	40	9200	3530	594	1188	353000
	30"	130212	830212	8.85	165	11.96	60	13800	4350	660	1319	435000
	40"	140212	840212	11.55	220	15.94	80	18400	6770	823	1646	677000
	50"	150212	850212	14.25	275	19.93	100	23000	8170	904	1808	817000
SPECTER HYPERSPOT	4"	17371	-	1.9	40	2.90	8	3520	1920	438	876	192000
	6"	17571	-	2.35	60	4.35	12	5280	2920	540	1081	292000
	10"	17871	-	3.45	75	5.43	20	7500	3880	623	1246	388000
	20"	12171	-	6.15	150	10.9	40	15000	7820	884	1769	782000
HYBRID SPOT/ FLOOD COMBO	6"	106312	806312	2.35	45	3.26	12	4500	690	263	525	69000
	10"	110312	810312	3.45	65	4.71	20	5740	1500	387	775	150000
	20"	120312	820312	6.15	110	7.97	40	9200	2620	512	1024	262000
	28"	128312	-	7.9	154	11.16	56	12880	3810	617	1234	380950
	30"	130312	830312	8.85	165	11.96	60	13800	4010	633	1266	401000
	38"	138312	-	11.1	209	15.14	76	17480	4646	682	1363	464550
	40"	140312	840312	11.55	220	15.94	80	18400	4890	699	1399	489000
50"	150312	850312	14.25	275	19.93	100	23000	6040	777	1554	604200	
SPECTER DRIVING/ HYPERSPOT COMBO	10"	17831	-	3.45	78	5.65	24	6888	2040	452	903	204000
	20"	12231	-	6.15	150	9.57	48	11040	4220	650	1299	422000
	28"	12731	-	7.9	176	12.75	64	14720	6403	800	1600	640300
	30"	13231	-	8.85	187	13.55	68	15640	6740	821	1642	674000
	38"	13731	-	11.1	231	16.74	84	19320	8797	938	1876	879700
	40"	14231	-	11.55	242	17.54	88	20240	9260	962	1925	926000
	50"	15231	-	14.25	297	21.52	108	24840	10180	1000	2018	1018000

* Raw Lumens is based on LED manufacturer specifications.**Distance with .25 lux and Peak Beam Intensity are tested using ANSI/NEMA FL standards.



LIGHTS COME WITH

- Mounting Hardware
- 3 Wind Isolators (40" & Up)

BLACK HOUSING ONLY

- 2 Black Powder Coated, L-Shape Brackets
- Harness w/Switch
- Deutsch Connector (4" - 30")
- Open Leads, No Connector (40" & Up)

WHITE HOUSING ONLY

- 2 Stainless Steel, L-Shape Brackets
- Open Leads, No Connector
- Harness Sold Separately
 - PN 40194 (4" - 6")
 - PN 40193 (10" - 30")
 - PN 40190 (40" & Up)

SR-SERIES[®]

The SR-Series LED Light Bars provide a sleek, low profile lighting solution that measures less than 2" tall. As the name implies, the SR-Series utilizes a single row of LEDs with your choice of Hybrid or patented Specter optics in a variety of beam patterns. Ideal for applications where space is limited, the SR-Series is a powerful light source designed to project light at extreme distances while consuming very little power. Available in a wide range of lengths and configurations, these LED light bars can be used on virtually any application or marine vessel.

RIGID's SR-Series lights are also available with a durable white finish. Though suitable for marine applications, RIGID's white lighting products are perfect for use anywhere an alternative to black is desired. The distinctive white is a durable UV-resistant powder coated finish with an additional chromate conversion coating for superior corrosion resistance. They feature the same legendary lighting technology and superior build quality as the rest of RIGID's lighting products, providing reliable and efficient lighting on demand.



**LOW PROFILE
LIGHTING
SOLUTION**





FEATURES

- 50,000+ Hour Lifespan
- 9-36 V DC
- Durable UV Polyester Powder Coat
- GORE® Pressure Equalizing Vent
- Harness & Switch Included (Exclusions Apply)
- High-Grade Aluminum Alloy Heatsink
- Integrated Thermal Management System
- Impact Resistant Polycarbonate Lens
- IP68 Compliant – Dust / Water Ingress
- 2 Mounting Brackets Included (1" and 3")
- Over / Under Voltage Protection
- Operating Temp -40° F ~ +145° F / -40° C ~ +60° C
- Protected Against RFI / EMI
- Patented Technology
- Reverse Polarity Protection
- RoHS Compliant
- SAE J575 Compliant – Shock / Vibration
- Waterproof Deutsch Connector (Exclusions Apply)

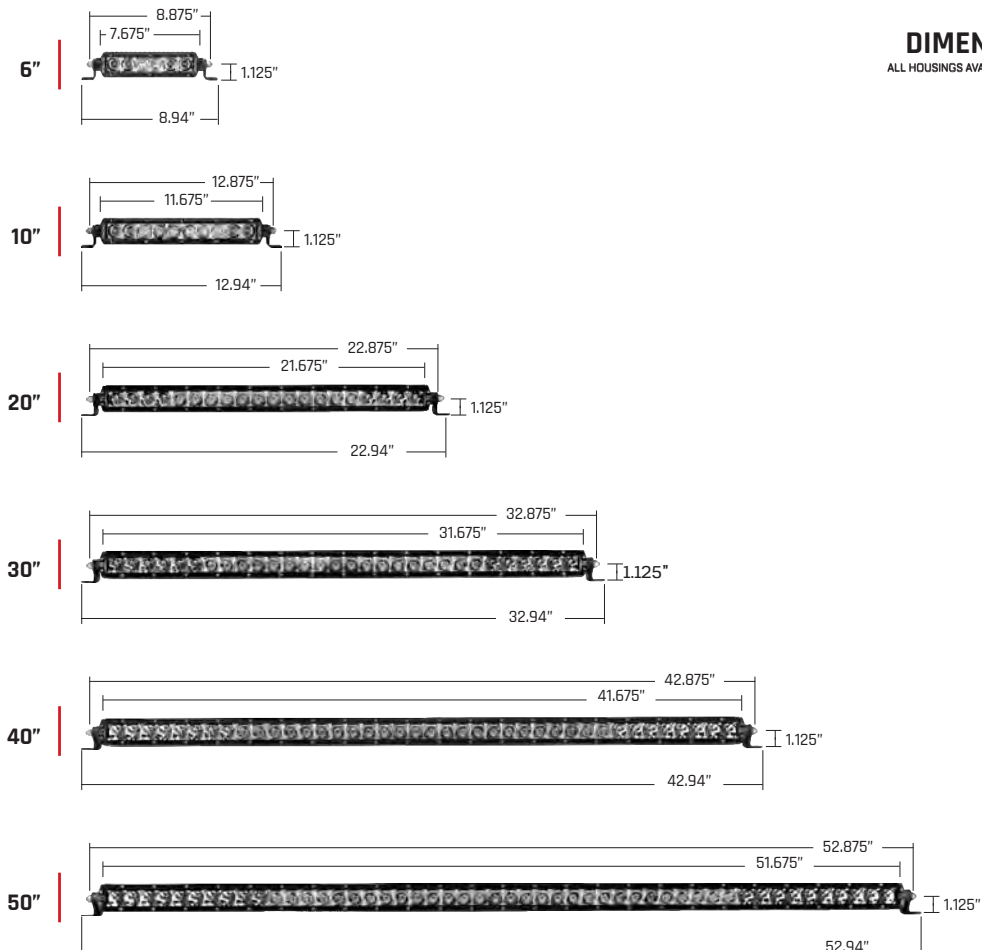

DIMENSIONS

ALL HOUSINGS AVAILABLE IN WHITE



WHAT BEAM
PATTERN WILL
SUIT MY NEEDS
THE BEST?



BEAM PATTERNS

Our custom designed graphs are intended to illustrate the beam patterns that our optics produce. First, consider what type of application the light is needed for and then choose what beam pattern best suits your needs. Each beam pattern varies depending on the optic or optic combination you choose. Once you know which beam pattern best suits your needs, refer to the specifications table (A, B, C) to determine how much LUX output you need and which product will best suit your application.

HYBRID DIFFUSED
Flood optic behind diffused lens

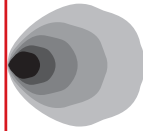

HYBRID FLOOD

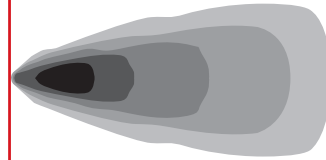

SPECTER DIFFUSED
Driving optic behind diffused lens

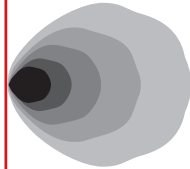

SPECTER DRIVING

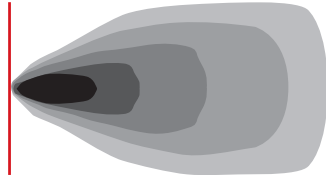

HYBRID SPOT



SPECTER HYPERSPOT



**HYBRID SPOT/
FLOOD COMBO**



**SPECTER DRIVING/
HYPERSPOT COMBO**

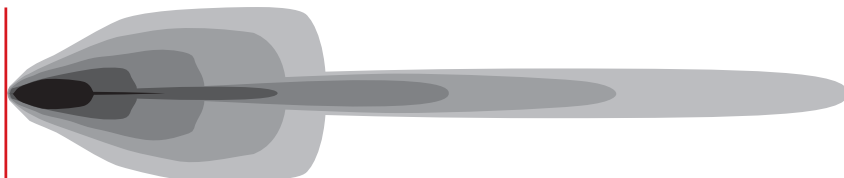

HOW MUCH
OUTPUT DO
I NEED?

A = LUX AT 10 METERS
B = BEAM DISTANCE (m) WITH 1 LUX
C = BEAM DISTANCE (m) WITH .25 LUX

SPECIFICATIONS

	SIZE	BLACK PART NO.	WHITE PART NO.	WT (LBS.)	WATTS	AMP DRAW @ 14VDC	LEDs	*RAW LUMENS	A	B	C	**PEAK BEAM INTENSITY(cd)
HYBRID DIFFUSED	6"	906512	30651	1.78	23.5	1.7	6	2250	17	41	82	1700
	10"	910512	31051	2.50	37.5	2.6	10	3750	29	54	108	2900
SPECTER DIFFUSED	6"	906692	90351	1.78	30.4	2.2	9	3375	28	53	106	2800
	10"	910692	91351	2.50	52.4	3.8	15	5625	47	69	137	4700
HYBRID FLOOD	6"	906112	30611	1.78	23.5	1.7	6	2250	97	98	197	9700
	10"	910112	31011	2.50	35.9	2.6	10	3750	147	121	242	14700
SPECTER DRIVING	6"	906612	90361	1.78	30.4	2.2	9	3375	210	145	290	21000
	10"	910612	91361	2.50	52.4	3.8	15	5625	290	170	341	29000
	20"	92161	-	5.43	120.1	7.61	30	11250	685	262	523	68500
HYBRID SPOT	6"	906212	30621	1.78	23.5	1.7	6	2250	730	270	540	73000
	10"	910212	91021	2.50	35.9	2.6	10	3750	1290	359	718	129000
SPECTER HYPERSPOT	6"	909712	-	1.78	30.4	2.2	6	2640	1310	362	724	131000
	10"	911712	-	2.50	35.9	2.6	10	3750	1920	438	876	192000
HYBRID SPOT/FLOOD COMBO	6"	906312	30631	1.78	23.5	1.7	6	2250	310	176	352	31000
	10"	910312	31031	2.50	35.9	2.6	10	3750	850	292	583	85000
	20"	92031	32031	5.43	75.9	5.5	20	7500	1750	418	837	175000
	30"	93031	33031	8.15	117.3	8.5	30	11250	2200	469	938	220000
	40"	94031	34031	10.87	162.8	11.8	40	15000	3260	571	1142	326000
SPECTER DRIVING/HYPERSPOT COMBO	10"	911312	-	2.50	56.6	4.1	12	4500	1210	348	696	121000
	20"	92131	-	5.43	105	8.7	26	9750	1960	443	885	196000
	30"	93131	-	8.15	143.5	10.4	36	13500	3115	558	1116	311500
	40"	94131	-	10.87	184.9	13.4	46	17250	4540	674	1348	454000
	50"	95131	-	13.59	226.3	16.4	56	21000	5440	738	1475	544000

* Raw Lumens is based on LED manufacturer specifications.**Distance with .25 lux and Peak Beam Intensity are tested using ANSI/NEMA FL standards.



LIGHTS COME WITH

• Mounting Hardware

BLACK HOUSING ONLY

- 2-1", 2-3" Black Powder Coated, L-Shape Brackets
- Harness w/Switch
- Deutsch Connector

WHITE HOUSING ONLY

- 2-1" Stainless Steel, L-Shape Brackets
- Open Leads, No Connector
- Harness Sold Separately
 - PN 40194 (4" - 10")
 - PN 40193 (20" - 50")

D-SERIES®

The D-Series is the most versatile compact lighting package on the market today. Available with a variety of mounting options, including surface, flush, or heavy-duty, the D-Series can be utilized for virtually any lighting application. Measuring just 3" x 3", the D-Series packs a powerful punch from 1568 to 3096 lumens depending on the optics chosen. Customers have used these versatile lights for reverse lights on a truck, a handlebar light for a motorcycle, flood lighting for a trailer, auxiliary lighting on agriculture and mining equipment, and many other applications that require a powerful, efficient light in a small space.

RIGID's D-Series lights are also available with a durable white finish. Though suitable for marine applications, RIGID's white lighting products are perfect for use anywhere an alternative to black is desired. The distinctive white is a durable UV-resistant powder coated finish with an additional chromate conversion coating for superior corrosion resistance. They feature the same legendary lighting technology and superior build quality as the rest of RIGID's lighting products, providing reliable and efficient lighting on demand.

**ADDITIONAL
VEHICLE SPECIFIC
MOUNTS SOLD
SEPARATELY**





FEATURES

- 50,000+ Hour Lifespan
- 9-36 V DC
- Durable UV Polyester Powder Coat
- GORE® Pressure Equalizing Vent
- Harness & Switch Included (Exclusions Apply)
- High-Grade Aluminum Alloy Heatsink
- Integrated Thermal Management System
- Impact Resistant Polycarbonate Lens
- IP68 Compliant - Dust / Water Ingress
- Mounting Brackets Included
- Over / Under Voltage Protection
- Operating Temp -40° F ~ +145° F / -40° C ~ +60° C
- Protected Against RFI / EMI
- Patented Technology
- Reverse Polarity Protection
- RoHS Compliant
- SAE J575 Compliant - Shock / Vibration
- Waterproof Deutsch Connector (Exclusions Apply)

DIMENSIONS & MOUNTS

FLUSH AND SURFACE MOUNT AVAILABLE IN WHITE



SURFACE MOUNT

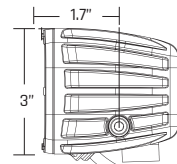
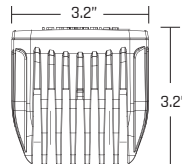

FLUSH MOUNT

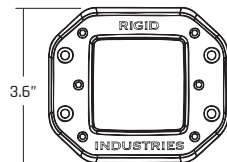
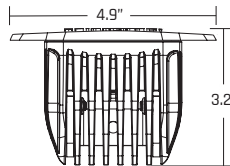

HEAVY DUTY MOUNT



ALSO AVAILABLE IN BLACK

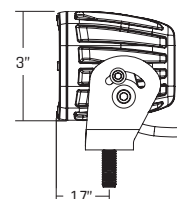
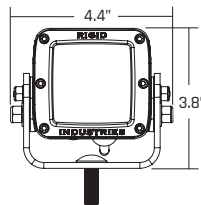

WHAT BEAM
PATTERN WILL
SUIT MY NEEDS
THE BEST?



BEAM PATTERNS

Our custom designed graphs are intended to illustrate the beam patterns that our optics produce. First, consider what type of application the light is needed for and then choose what beam pattern best suits your needs. Each beam pattern varies depending on the optic or optic combination you choose. Once you know which beam pattern best suits your needs, refer to the specifications table (A, B, C) to determine how much LUX output you need and which product will best suit your application.

HYBRID DIFFUSED
Flood optic behind diffused lens

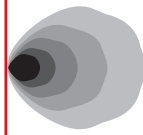

HYBRID FLOOD

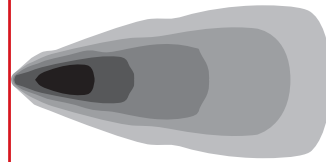

SPECTER DIFFUSED
Driving optic behind diffused lens

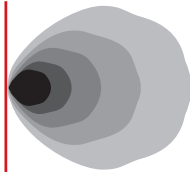

SPECTER DRIVING

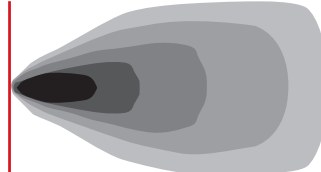

HYBRID SPOT

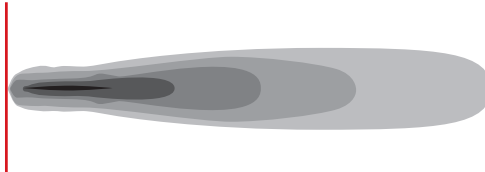

SPECTER HYPERSPOT

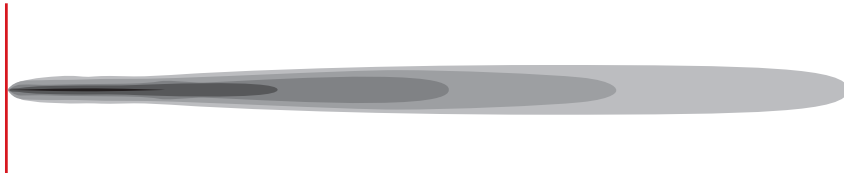

HOW MUCH
OUTPUT DO
I NEED?

A = LUX AT 10 METERS
B = BEAM DISTANCE (m) WITH 1 LUX
C = BEAM DISTANCE (m) WITH .25 LUX

SPECIFICATIONS



	MOUNT	BLACK SINGLE	BLACK PAIR	WHITE SINGLE	WHITE PAIR	WT. (LBS.)	WATTS	AMP DRAW @14VDC	LEDs	*RAW LUMENS	A	B	C	**PEAK BEAM INTENSITY(cd)
HYBRID DIFFUSED	SM	20151	20251	60151	60251	1.1	15.8	1.1	4	1568	11	33	66	1100
	FM	21151	21251	61151	61251	1.17	15.8	1.1	4	1568	11	33	66	1100
	HD	22151	22251	-	-	1.40	15.8	1.1	4	1568	11	33	66	1100
	Y/HD	23151	23251	-	-	1.40	15.8	1.1	4	1568	11	33	66	1100
SPECTER DIFFUSED	SM	50151	50251	70151	70251	1.1	34.5	2.5	6	3096	20	45	89	2000
	FM	51151	51251	71151	71251	1.17	34.5	2.5	6	3096	20	45	89	2000
	HD	52151	52251	-	-	1.40	34.5	2.5	6	3096	20	45	89	2000
	Y/HD	53151	53251	-	-	1.40	34.5	2.5	6	3096	20	45	89	2000
HYBRID FLOOD	SM	20111	20211	60111	60211	1.1	15.8	1.1	4	1568	55	74	148	5500
	FM	21111	21211	61111	61211	1.17	15.8	1.1	4	1568	55	74	148	5500
	HD	22111	22211	-	-	1.40	15.8	1.1	4	1568	55	74	148	5500
	Y/HD	23111	23211	-	-	1.40	15.8	1.1	4	1568	55	74	148	5500
SPECTER DRIVING	SM	50131	50231	70131	70231	1.1	34.5	2.5	6	3096	203	142	285	20300
	FM	51131	51231	71131	71231	1.17	34.5	2.5	6	3096	203	142	285	20300
	HD	52131	52231	-	-	1.40	34.5	2.5	6	3096	203	142	285	20300
	Y/HD	53131	53231	-	-	1.40	34.5	2.5	6	3096	203	142	285	20300
HYBRID SPOT	SM	20121	20221	60121	60221	1.1	15.8	1.1	4	1568	646	254	508	64600
	FM	21121	21221	61121	61221	1.17	15.8	1.1	4	1568	646	254	508	64600
	HD	22121	22221	-	-	1.40	15.8	1.1	4	1568	646	254	508	64600
	Y/HD	23121	23221	-	-	1.40	15.8	1.1	4	1568	646	254	508	64600
SPECTER HYPERSPOT	SM	50371	50471	-	-	1.1	20.1	1.45	4	1760	930	305	610	93000

* Raw Lumens is based on LED manufacturer specifications.**Distance with .25 lux and Peak Beam Intensity are tested using ANSI/NEMA FL standards.
(SM) = Surface Mount, (FM) = Flush Mount, (HD) = All Black Heavy Duty, (Y/HD) = Yellow Heavy Duty



LIGHTS COME WITH

- Mounting Hardware
- Stainless Steel, U-Shape Bracket (Excludes FM)
- Vibration Isolators (Heavy Duty Surface Only)

- BLACK HOUSING ONLY**
- Harness w/Switch
 - Deutsch Connector

- WHITE HOUSING ONLY**
- Open Leads, No Connector
 - Harness Sold Separately
 - PN 40194 (Single Lights)
 - PN 40195 (Pair / Hybrid)
 - PN 40196 (Pair / Specter)

DUALLY XL™

With the enormous popularity of the original D-Series came the need for a slightly larger, more powerful lighting solution. The Dually XL's 4"x4" housing packs additional LEDs for increased light output while maintaining the efficiency that is the hallmark of the entire Rigid Industries' product line. Featuring an unbreakable polycarbonate lens, durable UV-resistant polyester powder coat, stainless steel hardware, and a vibration isolator, the Dually XL Series is available with your choice of beam pattern and either Hybrid or Specter optics. Whether it's off-road, power sports, general automotive, mining, agriculture, or fire and rescue, the Dually XL is perfect for any application that requires a high intensity LED light.

RIGID's Dually XL lights are also available with a durable white finish. Though suitable for marine applications, RIGID's white lighting products are perfect for use anywhere an alternative to black is desired. The distinctive white is a durable UV-resistant powder coated finish with an additional chromate conversion coating for superior corrosion resistance. They feature the same legendary lighting technology and superior build quality as the rest of RIGID's lighting products, providing reliable and efficient lighting on demand.

**INCREASED LIGHT
OUTPUT WHILE
MAINTAINING
EFFICIENCY**





FEATURES

- 50,000+ Hour Lifespan
- 9-36 V DC
- Durable UV Polyester Powder Coat
- GORE® Pressure Equalizing Vent
- Harness & Switch Included (Exclusions Apply)
- High-Grade Aluminum Alloy Heatsink
- Integrated Thermal Management System
- Impact Resistant Polycarbonate Lens
- IP68 Compliant - Dust / Water Ingress
- Mounting Brackets Included
- Over / Under Voltage Protection
- Operating Temp -40° F ~ +145° F / -40° C ~ +60° C
- Protected Against RFI / EMI
- Patented Technology
- Reverse Polarity Protection
- RoHS Compliant
- SAE J575 Compliant - Shock / Vibration
- Waterproof Deutsch Connector (Exclusions Apply)

DIMENSIONS & MOUNTS

ALL HOUSINGS AVAILABLE IN WHITE



SURFACE MOUNT

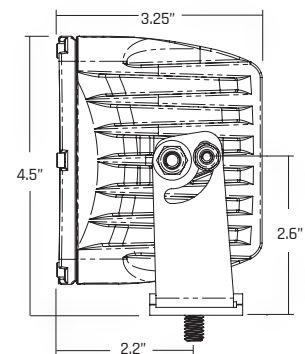
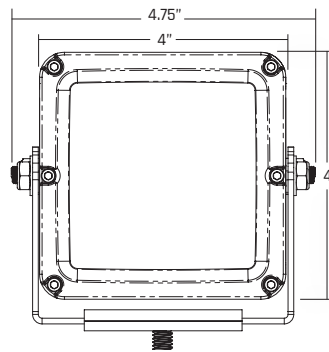

WHAT BEAM
PATTERN WILL
SUIT MY NEEDS
THE BEST?



BEAM PATTERNS

Our custom designed graphs are intended to illustrate the beam patterns that our optics produce. First, consider what type of application the light is needed for and then choose what beam pattern best suits your needs. Each beam pattern varies depending on the optic or optic combination you choose. Once you know which beam pattern best suits your needs, refer to the specifications table (A, B, C) to determine how much LUX output you need and which product will best suit your application.

HYBRID DIFFUSED

Flood optic behind diffused lens

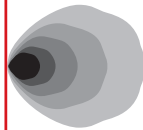

HYBRID FLOOD

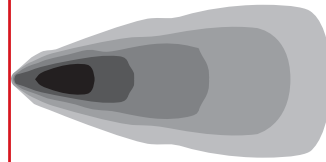

SPECTER DIFFUSED

Driving optic behind diffused lens

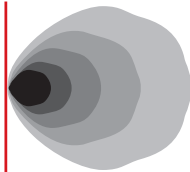
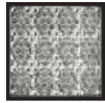

SPECTER DRIVING

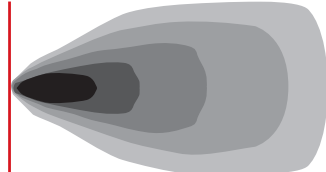

HYBRID SPOT

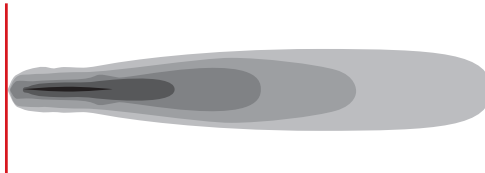

SPECTER HYPERSPOT

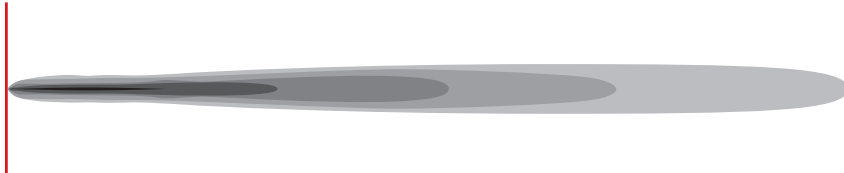

**HOW MUCH
OUTPUT DO
I NEED?**

A = LUX AT 10 METERS
B = BEAM DISTANCE (m) WITH 1 LUX
C = BEAM DISTANCE (m) WITH .25 LUX

SPECIFICATIONS



	MOUNT	BLACK SINGLE	BLACK PAIR	WHITE SINGLE	WHITE PAIR	WT. (LBS.)	WATTS	AMP DRAW @ 14V	LEDs	*RAW LUMENS	A	B	C	**PEAK BEAM INTENSITY(cd)
HYBRID DIFFUSED	SM	32131	32231	32331	32431	1.79	34	2.36	9	2646	19	44	88	1932
SPECTER DIFFUSED	SM	32171	32271	32371	32471	1.78	47	3.26	12	3969	36	60	120	3617
HYBRID FLOOD	SM	32111	32211	32311	32411	1.79	34	2.36	9	2646	86	93	185	8579
SPECTER DRIVING	SM	32161	32261	32361	32461	1.78	43	2.99	12	3969	279	167	3334	27929
HYBRID SPOT	SM	32121	32221	32321	32421	1.79	34	2.36	9	2646	1035	322	644	103528
SPECTER HYPERSPOT	SM	32141	32241	-	-	1.84	33	2.29	9	2646	2081	455	912	208186

* Raw Lumens is based on LED manufacturer specifications.**Distance with .25 lux and Peak Beam Intensity are tested using ANSI/NEMA FL standards. (SM) = Surface Mount



LIGHTS COME WITH

- Mounting Hardware
- Stainless Steel, U-Shape Bracket
- Vibration Isolators

- BLACK HOUSING ONLY**
- Harness w/Switch
 - Deutsch Connector

- WHITE HOUSING ONLY**
- Open Leads, No Connector
 - Harness Sold Separately
 - PN 40193 (Single)
 - PN 40196 (Pair)

Q-SERIES[®]

The Q-Series is designed and built to withstand the harshest working environments imaginable. Constructed of the toughest and most durable materials available, including a double-pass TIG-welded stainless steel bracket with vibration isolator, the Q-Series provides reliable, powerful LED light and is tough enough to withstand mining, agriculture, construction, and the oil and gas industries. The rugged construction also makes it well suited to extreme environments. If the application is severe, the Q-Series is the ultimate lighting solution.

RIGID's Q-Series lights are also available with a durable white finish. Though suitable for marine applications, RIGID's white lighting products are perfect for use anywhere an alternative to black is desired. The distinctive white is a durable UV-resistant powder coated finish with an additional chromate conversion coating for superior corrosion resistance. They feature the same legendary lighting technology and superior build quality as the rest of RIGID's lighting products, providing reliable and efficient lighting on demand.



**THE ULTIMATE
LIGHTING
SOLUTION**



FEATURES

- 50,000+ Hour Lifespan
- 9-36 V DC
- Durable UV Polyester Powder Coat
- GORE® Pressure Equalizing Vent
- Harness & Switch Included (Exclusions Apply)
- High-Grade Aluminum Alloy Heatsink
- Integrated Thermal Management System
- Impact Resistant Polycarbonate Lens
- IP68 Compliant – Dust / Water Ingress
- Mounting Brackets Included
- Over / Under Voltage Protection
- Operating Temp -40° F ~ +145° F / -40° C ~ +60° C
- Protected Against RFI / EMI
- Patented Technology
- Reverse Polarity Protection
- RoHS Compliant
- SAE J575 Compliant – Shock / Vibration
- Waterproof Deutsch Connector (Exclusions Apply)

DIMENSIONS & MOUNTS

ALL HOUSINGS AVAILABLE IN WHITE



SURFACE MOUNT

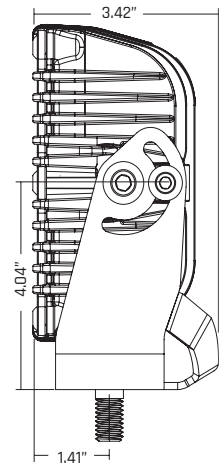
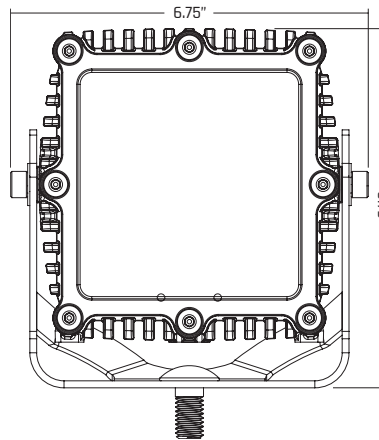

WHAT BEAM PATTERN WILL SUIT MY NEEDS THE BEST?



BEAM PATTERNS

Our custom designed graphs are intended to illustrate the beam patterns that our optics produce. First, consider what type of application the light is needed for and then choose what beam pattern best suits your needs. Each beam pattern varies depending on the optic or optic combination you choose. Once you know which beam pattern best suits your needs, refer to the specifications table (A, B, C) to determine how much LUX output you need and which product will best suit your application.

HYBRID DIFFUSED
Flood optic behind diffused lens

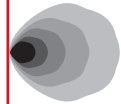

HYBRID FLOOD

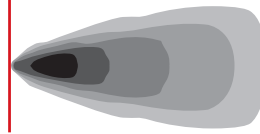

SPECTER DIFFUSED
Driving optic behind diffused lens

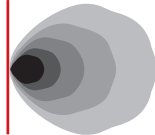

SPECTER DRIVING

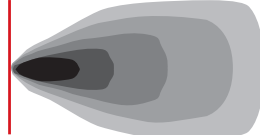

**HYBRID FLOOD/
DIFFUSED COMBO**

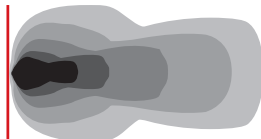

SPECTER WIDE

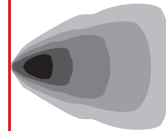

**HYBRID SPOT/
DIFFUSED COMBO**

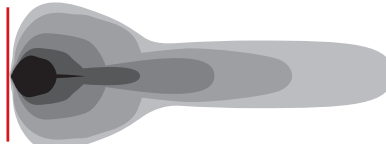

**SPECTER DRIVING/
DIFFUSED COMBO**

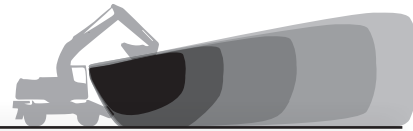
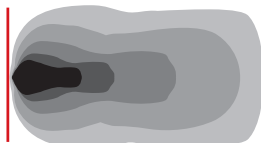

SIDE VIEW - COMBO WITH DIFFUSED

**SPECTER DRIVING/
HYSPERSPOT COMBO**

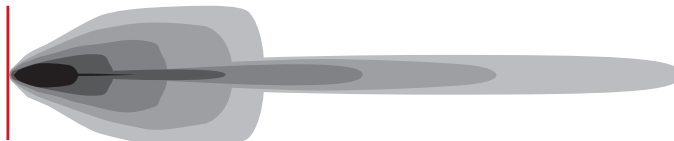

HYBRID SPOT

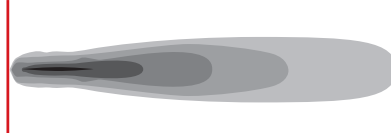

SPECTER HYPERSPOT



HOW MUCH
OUTPUT DO
I NEED?

A = LUX AT 10 METERS
B = BEAM DISTANCE (m) WITH 1 LUX
C = BEAM DISTANCE (m) WITH .25 LUX

SPECIFICATIONS



	MOUNT	BLACK SINGLE	BLACK PAIR	WHITE SINGLE	WHITE PAIR	WT. (LBS.)	WATTS	AMP DRAW @ 14VDC	LEDs	*RAW LUMENS	A	B	C	**PEAK BEAM INTENSITY(cd)
HYBRID DIFFUSED	SM	24451	-	24551	-	2.8	80	5.8	16	7040	55	74	148	5500
SPECTER DIFFUSED	SM	54451	-	54551	-	2.8	90	6.5	24	9000	78	88	177	7800
HYBRID FLOOD	SM	24411	-	24511	-	2.8	80	5.8	16	7040	169	130	260	16928
SPECTER DRIVING	SM	54431	-	54531	-	2.8	90	6.5	24	9000	520	228	456	52000
SPECTER WIDE	SM	54411	-	54511	-	2.8	90	6.5	24	9000	450	212	424	45000
HYBRID FLOOD/ DIFFUSED COMBO	SM	24471	-	24571	-	2.8	80	5.8	16	7040	92	96	192	9200
HYBRID SPOT/ DIFFUSED COMBO	SM	24461	-	24561	-	2.8	80	5.8	16	7040	1060	326	651	106000
SPECTER DRIVING/ DIFFUSED COMBO	SM	54461	-	54561	-	2.8	90	6.5	24	9000	113	106	213	11300
SPECTER DRIVING/ HYPERSPOT COMBO	SM	54481	-	54581	-	2.8	75	5.4	20	7500	1632	404	808	163200
HYBRID SPOT	SM	24421	-	24521	-	2.8	80	5.8	16	7040	1840	429	858	184000
SPECTER HYPERSPOT	SM	54471	-	-	-	2.8	80	5.8	16	7040	3280	573	1145	328000

*Raw Lumens is based on LED manufacturer specifications.**Distance with .25 lux and Peak Beam Intensity are tested using ANSI/NEMA FL standards.
(SM) = Surface Mount



LIGHTS COME WITH

- Mounting Hardware
- Stainless Steel, Heavy Duty U-Shape Bracket
- Vibration Isolators

BLACK HOUSING ONLY

- Harness w/Switch
- Deutsch Connector

WHITE HOUSING ONLY

- Open Leads, No Connector
- Harness Sold Separately
- PN 40193 (Single)

SR-Q[®] SERIES

The SR-Q Series is a sleek low profile lighting option with a light output equivalent to that of the D-Series. An excellent choice for any application where space is limited, the SR-Q Series has a single row of LEDs and is available in multiple beam patterns, including Spot, Flood, Driving, Wide, Hyperspot, and Diffused; as well as being offered in UV. Both surface and flush mount options are available and there are multiple mounting capabilities, such as the Suction Cup Mount and Angled Flush Mounts, just to name a few. The SR-Q Series is also a perfect back-up light and is available as a Back-Up Light Kit with a 25' harness and a three position switch for ease of wiring and usage.

RIGID's SR-Q Series lights are also available with a durable white finish. Though suitable for marine applications, RIGID's white lighting products are perfect for use anywhere an alternative to black is desired. The distinctive white is a durable UV-resistant powder coated finish with an additional chromate conversion coating for superior corrosion resistance. They feature the same legendary lighting technology and superior build quality as the rest of RIGID's lighting products, providing reliable and efficient lighting on demand.



**PERFECT
BACK-UP
LIGHT**



FEATURES

- 50,000+ Hour Lifespan
- 9-36 V DC
- Durable UV Polyester Powder Coat
- GORE® Pressure Equalizing Vent
- Harness & Switch Included (Exclusions Apply)
- High-Grade Aluminum Alloy Heatsink
- Integrated Thermal Management System
- Impact Resistant Polycarbonate Lens
- IP68 Compliant - Dust / Water Ingress
- Mounting Brackets Included
- Over / Under Voltage Protection
- Operating Temp -40° F ~ +145° F / -40° C ~ +60° C
- Protected Against RFI / EMI
- Patented Technology
- Reverse Polarity Protection
- RoHS Compliant
- SAE J575 Compliant - Shock / Vibration
- Waterproof Deutsch Connector (Exclusions Apply)

DIMENSIONS & MOUNTS

ALL HOUSINGS AVAILABLE IN WHITE



SURFACE MOUNT

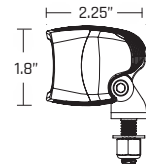
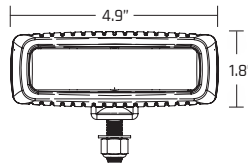

FLUSH MOUNT

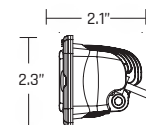
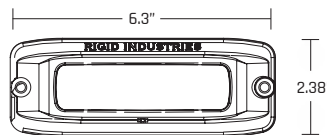

WHAT BEAM
PATTERN WILL
SUIT MY NEEDS
THE BEST?



BEAM PATTERNS

Our custom designed graphs are intended to illustrate the beam patterns that our optics produce. First, consider what type of application the light is needed for and then choose what beam pattern best suits your needs. Each beam pattern varies depending on the optic or optic combination you choose. Once you know which beam pattern best suits your needs, refer to the specifications table (A, B, C) to determine how much LUX output you need and which product will best suit your application.

HYBRID DIFFUSED
Flood optic behind diffused lens

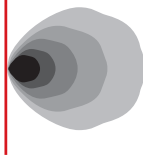

HYBRID FLOOD

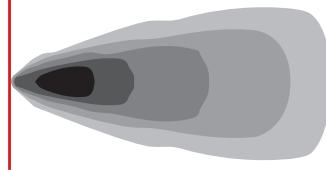

SPECTER DIFFUSED
Driving optic behind diffused lens

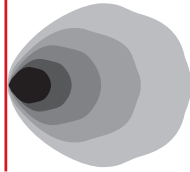

SPECTER DRIVING

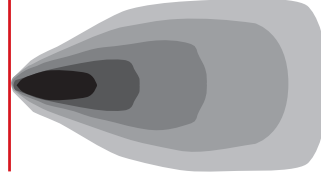

SPECTER WIDE

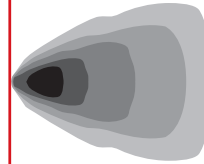

HYBRID SPOT

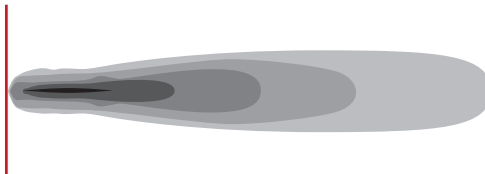

SPECTER HYPERSPOT

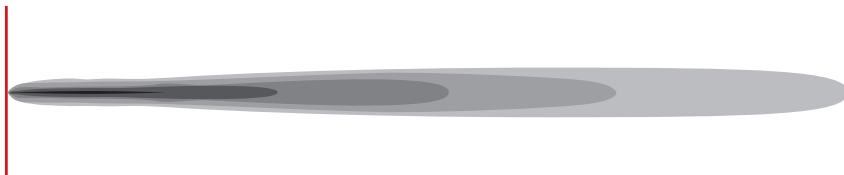

HOW MUCH
OUTPUT DO
I NEED?

A = LUX AT 10 METERS
B = BEAM DISTANCE (m) WITH 1 LUX
C = BEAM DISTANCE (m) WITH .25 LUX

SPECIFICATIONS



	MOUNT	BLACK SINGLE	BLACK PAIR	WHITE SINGLE	WHITE PAIR	WT (LBS.)	WATTS	AMP DRAW @ 14VDC	LEDS	*RAW LUMENS	A	B	C	**PEAK BEAM INTENSITY (cd)
HYBRID DIFFUSED	SM	90451	90551	94451	94551	.75	15	1.1	4	1568	15.2	39	78	1520
	FM	92451	92551	96451	96551	.9	15	1.1	4	1568	15.2	39	78	1520
SPECTER DIFFUSED	SM	91451	91551	95451	95551	.75	34.5	2.5	6	3096	20	45	89	2000
	FM	93451	93551	97451	97551	.9	34.5	2.5	6	3096	20	45	89	2000
HYBRID FLOOD	SM	90411	90511	94411	94511	.75	15	1.1	4	1568	96	98	196	9600
	FM	92411	92511	96411	96511	.9	15	1.1	4	1568	96	98	196	9600
SPECTER DRIVING	SM	91431	91531	95431	95531	.75	34.5	2.5	6	3096	203	142	285	20300
	FM	93431	93531	97431	97531	.9	34.5	2.5	6	3096	203	142	285	20300
SPECTER WIDE	SM	91411	91511	95411	95511	.75	34.5	2.5	6	3096	173	132	263	17300
	FM	93411	93511	97411	97511	.9	34.5	2.5	6	3096	173	132	263	17300
HYBRID SPOT	SM	90421	90521	94421	94521	.75	15	1.1	4	1568	646	254	508	64600
	FM	92421	92521	96421	96521	.9	15	1.1	4	1568	646	254	508	64600
SPECTER HYPERSPOT	SM	91671	91681	-	-	.9	20	1.4	4	1760	930	305	610	93000
SPECTER UV DRIVING	SM	91639	-	-	-	.75	-	-	6	4800 milliwatts at 395 nanometers				
SPECTER UV DIFFUSED	SM	91659	-	-	-	.75	-	-	6	4800 milliwatts at 395 nanometers				

* Raw Lumens is based on LED manufacturer specifications.**Distance with .25 lux and Peak Beam intensity are tested using ANSI/NEMA FL standards.
(SM) = Surface Mount, (FM) = Flush Mount



LIGHTS COME WITH

- Mounting Hardware
- Stainless Steel, U-Shape Bracket (Excludes FM)
- Solid Black Light Cover (Excludes FM)

BLACK HOUSING ONLY

- Harness w/Switch
- Deutsch Connector

WHITE HOUSING ONLY

- Open Leads, No Connector
- Harness Sold Separately
 - PN 40194 (Singles)
 - PN 40195 (Pair / Hybrid)
 - PN 40196 (Pair / Specter)

SR-M[®] SERIES

Among the smallest, most compact products that Rigid Industries offers, the SR-M (Single Row Mini) still packs a lot of lighting power. The size of the SR-M Series makes it highly adaptable to a variety of uses, including everything from a flood light on a toy hauler, handlebar-mounted lights for motorcycles and many other power sports applications. Common automotive uses include back bumper lighting. With a range of beam patterns in your choice of Hybrid or Specter Optics, the SR-M series is one of the brightest mini LED lights on the market.

RIGID's SR-M Series lights are also available with a durable white finish. Though suitable for marine applications, RIGID's white lighting products are perfect for use anywhere an alternative to black is desired. The distinctive white is a durable UV-resistant powder coated finish with an additional chromate conversion coating for superior corrosion resistance. They feature the same legendary lighting technology and superior build quality as the rest of RIGID's lighting products, providing reliable and efficient lighting on demand.





FEATURES

- 50,000+ Hour Lifespan
- 9-36 V DC
- Durable UV Polyester Powder Coat
- GORE® Pressure Equalizing Vent
- Harness & Switch Included (Exclusions Apply)
- High-Grade Aluminum Alloy Heatsink
- Integrated Thermal Management System
- Impact Resistant Polycarbonate Lens
- IP68 Compliant - Dust / Water Ingress
- Mounting Brackets Included
- Over / Under Voltage Protection
- Operating Temp -40° F ~ +145° F / -40° C ~ +60° C
- Protected Against RFI / EMI
- Patented Technology
- Reverse Polarity Protection
- RoHS Compliant
- SAE J575 Compliant - Shock / Vibration
- Waterproof Deutsch Connector (Exclusions Apply)

DIMENSIONS & MOUNTS

ALL HOUSINGS AVAILABLE IN WHITE



SURFACE MOUNT

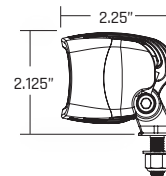
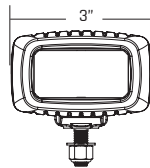

FLUSH MOUNT

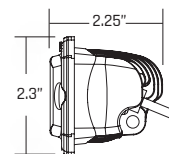
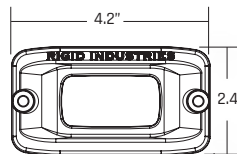

WHAT BEAM
PATTERN WILL
SUIT MY NEEDS
THE BEST?



BEAM PATTERNS

Our custom designed graphs are intended to illustrate the beam patterns that our optics produce. First, consider what type of application the light is needed for and then choose what beam pattern best suits your needs. Each beam pattern varies depending on the optic or optic combination you choose. Once you know which beam pattern best suits your needs, refer to the specifications table (A, B, C) to determine how much LUX output you need and which product will best suit your application.

HYBRID DIFFUSED
Flood optic behind diffused lens

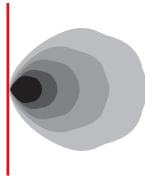

HYBRID FLOOD

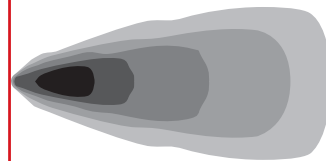

SPECTER DIFFUSED
Driving optic behind diffused lens

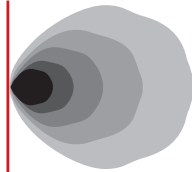

SPECTER DRIVING

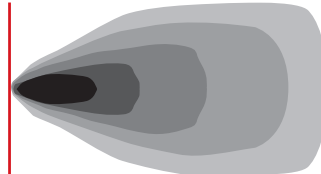

SPECTER WIDE

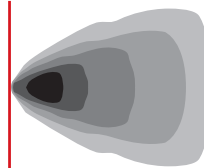

HYBRID SPOT

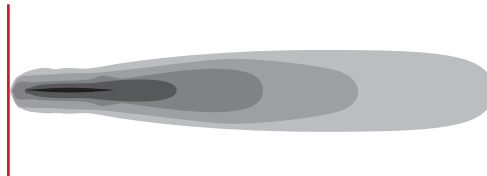

HOW MUCH
OUTPUT DO
I NEED?

A = LUX AT 10 METERS
B = BEAM DISTANCE (m) WITH 1 LUX
C = BEAM DISTANCE (m) WITH .25 LUX

SPECIFICATIONS



	MOUNT	BLACK SINGLE	BLACK PAIR	WHITE SINGLE	WHITE PAIR	WT (LBS.)	WATTS	AMP DRAW @ 14VDC	LEDS	*RAW LUMENS	A	B	C	**PEAK BEAM INTENSITY (cd)
HYBRID DIFFUSED	SM	90251	-	94251	-	.38	9.9	0.72	2	880	11	33	66	1100
	FM	92251	-	96251	-	.45	9.9	0.72	2	880	11	33	66	1100
SPECTER DIFFUSED	SM	91251	-	95251	-	.38	11	0.8	3	1125	11.3	34	67	1130
	FM	93251	-	97251	-	.45	11	0.8	3	1125	11.3	34	67	1130
HYBRID FLOOD	SM	90211	-	94211	-	.38	9.9	0.72	2	880	55	74	148	5500
	FM	92211	-	96211	-	.45	9.9	0.72	2	880	55	74	148	5500
SPECTER DRIVING	SM	91231	-	95231	-	.38	11	0.8	3	1125	77.4	88	176	7740
	FM	93231	-	97231	-	.45	11	0.8	3	1125	77.4	88	176	7740
SPECTER WIDE	SM	91211	-	95211	-	.38	11	0.8	3	1125	64	80	160	6400
	FM	93211	-	97211	-	.45	11	0.8	3	1125	64	80	160	6400
HYBRID SPOT	SM	90221	-	94221	-	.38	9.9	0.72	2	880	271	165	329	27100
	FM	92221	-	96221	-	.45	9.9	0.72	2	880	271	165	329	27100
SPECTER UV DRIVING	SM	91339	-	-	-	.38	-	-	3	2400 milliwatts at 395 nanometers				
SPECTER UV DIFFUSED	SM	91359	-	-	-	.38	-	-	3	2400 milliwatts at 395 nanometers				

* Raw Lumens is based on LED manufacturer specifications.**Distance with .25 lux and Peak Beam Intensity are tested using ANSI/NEMA FL standards.
(SM) = Surface Mount, (FM) = Flush Mount



LIGHTS COME WITH

- Mounting Hardware
- Stainless Steel, U-Shape Bracket (Excludes FM)
- Solid Black Light Cover (Excludes FM)

- BLACK HOUSING ONLY**
- Harness w/Switch
 - Deutsch Connector

- WHITE HOUSING ONLY**
- Open Leads, No Connector
 - Harness Sold Separately
- PN 40199 (Single)

A-SERIES®

The A-Series LED Accessory Light is the universal light that can be used just about anywhere. Vehicle cabs, boat cabins, work vehicle beds, under the hood of a vehicle and trunks are just a few of the places where the A-Series can provide handy bright lighting in otherwise dark environments. The A-Series has a durable compact aluminum housing and includes rubber flat-mount, 3M™ VHB™, 2 way pad for flat mounting, and radius tube-mount adapters, which provide side or bottom wire exits to accommodate different applications. It is lightweight, waterproof, and available in a variety of different LED colors in high and low power versions. The versatility of the A-Series makes it an easy installation on almost anything.

COLOR SELECTION



COOL WHITE

• Cool White matches the Kelvin of all other white LED lights.

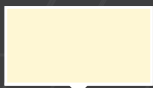

WARM WHITE

• Warm White is comparable to a 60-watt incandescent light bulb

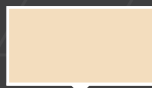

NATURAL WHITE

• Natural White is similar to being outside on a sunny day.



RED



BLUE



AMBER



GREEN



**MINIMUM
SPACE.
MAXIMUM
POWER.**

Triplex™ coating is three to five times stronger than MIL-A-8625, the military set specification for anodic coatings. Salt chamber testing exceeded 9,000 hours with zero pitting or corrosion.



TRIPLEX™



FEATURES

- 50,000+ Hour Lifespan
- 10-28 V DC
- Durable UV Polyester Powder Coat
- 2-Wire Open Lead for Convenient Wiring
- High-Grade Aluminum Alloy Heatsink
- Integrated Thermal Management System
- Impact Resistant Polycarbonate Lens
- IP68 Compliant – Dust / Water Ingress
- Mount Adapters Included
- Over / Under Voltage Protection
- Operating Temp -40° F ~ +145° F / -40° C ~ +60° C
- Protected Against RFI / EMI
- Patented Technology
- Reverse Polarity Protection
- RoHS Compliant
- SAE J575 Compliant – Shock / Vibration
- Epoxy Sealed, No Vent
- 24" Molded Wire Ingress



LIGHTS COME WITH

- Mounting Hardware
- 2 Mounting Hole Rubber Plugs
- 1 Adhesive Primer
- 1 VHB Mount Tape
- 1 Flat Mount Adapter
- 1 Tube Mount Adapter
- 3ft. Wire Extension
- 2-Wire Open Lead, No Connector

FLAT MOUNT



BOTTOM WIRE EXIT



SIDE WIRE EXIT



SIDE OR BOTTOM WIRE EXIT

DIMENSIONS & MOUNTS

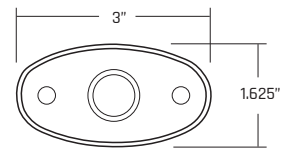

*Dimensions shown without adapter

SPECIFICATIONS

LIGHT COLOR	BLACK		WHITE		TRIPLEX™		
	SINGLE PART NO	PAIR PART NO.	SINGLE PART NO	PAIR PART NO	SINGLE PART NO	PAIR PART NO	
LOW POWER	WARM WHITE	48001	48201	48013	48213	-	-
	NATURAL WHITE	48002	48202	48014	48214	-	-
	COOL WHITE	48003	48203	48015	48215	-	-
	RED	48004	48204	48016	48216	-	-
	BLUE	48005	48205	48017	48217	-	-
	GREEN	48006	48206	48018	48218	-	-
	AMBER	48034	48234	48032	48232	-	-
HIGH POWER	WARM WHITE	48007	48207	48019	48219	48025	48225
	NATURAL WHITE	48008	48208	48020	48220	48026	48226
	COOL WHITE	48009	48209	48021	48221	48027	48227
	RED	48010	48210	48022	48222	48028	48228
	BLUE	48011	48211	48023	48223	48029	48229
	GREEN	48012	48212	48024	48224	48030	48230
	AMBER	48033	48233	48031	48231	48035	48235

R-SERIES 46™

Rigid Industries entered the world of round lighting with the release of the R-Series 46, which combines innovative LED technology with the classic round shape of traditional auxiliary lighting. The R-Series 46 mirrors the size of the common Par 46 in size, making it easy to both utilize modern LED technology in common older applications, and also retrofit Rigid Industries' leading technology into existing fixtures, such as police spotlights, tractor headlights, and other heavy machinery. The R-Series 46 provides a powerful beam of light and a 50,000 hour lifespan that is far superior to traditional incandescent bulbs, all while using a fraction of the power. The R-Series 46 is available with stand-alone surface mounting and as a direct-fit replacement for Par 46 bulbs.

RIGID's R-Series 46 lights are also available with a durable white finish. Though suitable for marine applications, RIGID's white lighting products are perfect for use anywhere an alternative to black is desired. The distinctive white is a durable UV-resistant powder coated finish with an additional chromate conversion coating for superior corrosion resistance. They feature the same legendary lighting technology and superior build quality as the rest of RIGID's lighting products, providing reliable and efficient lighting on demand.

**THE WORLD
OF ROUND JUST
GOT RIGID**





FEATURES

- 50,000+ Hour Lifespan
- 9-36 V DC
- Durable UV Polyester Powder Coat
- GORE® Pressure Equalizing Vent
- Harness & Switch Included (Exclusions Apply)
- High-Grade Aluminum Alloy Heatsink
- Integrated Thermal Management System
- Impact Resistant Polycarbonate Lens
- IP68 Compliant - Dust / Water Ingress
- Mounting Brackets Included
- Over / Under Voltage Protection
- Operating Temp -40° F ~ +145° F / -40° C ~ +60° C
- Protected Against RFI / EMI
- Patented Technology
- Reverse Polarity Protection
- RoHS Compliant
- SAE J575 Compliant - Shock / Vibration
- Waterproof Deutsch Connector (Exclusions Apply)

DIMENSIONS & MOUNTS

ALL HOUSINGS AVAILABLE IN WHITE



SURFACE MOUNT

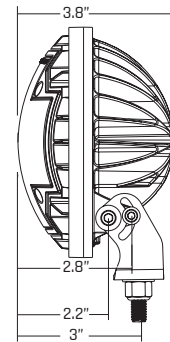
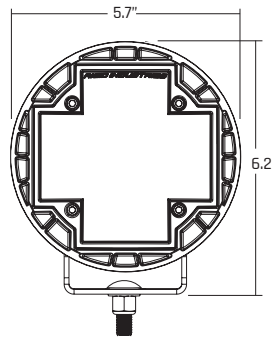

RETROFIT

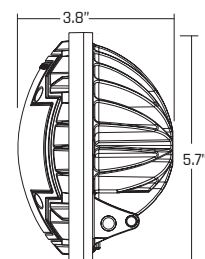
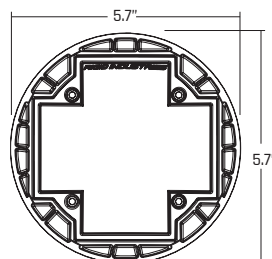

WHAT BEAM
PATTERN WILL
SUIT MY NEEDS
THE BEST?



BEAM PATTERNS

Our custom designed graphs are intended to illustrate the beam patterns that our optics produce. First, consider what type of application the light is needed for and then choose what beam pattern best suits your needs. Each beam pattern varies depending on the optic or optic combination you choose. Once you know which beam pattern best suits your needs, refer to the specifications table (A, B, C) to determine how much LUX output you need and which product will best suit your application.

HYBRID FLOOD

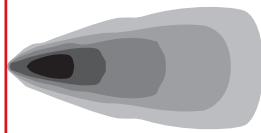

SPECTER DRIVING

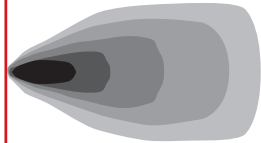

HYBRID SPOT



SPECTER HYPERSPOT



HYBRID SPOT/
FLOOD COMBO



SPECTER DRIVING/
HYPERSPOT COMBO



HYBRID SPOT/
SPECTER HYPERSPOT COMBO



HOW MUCH
OUTPUT DO
I NEED?

A = LUX AT 10 METERS
B = BEAM DISTANCE (m) WITH 1 LUX
C = BEAM DISTANCE (m) WITH .25 LUX

SPECIFICATIONS



	MOUNT	BLACK SINGLE	BLACK PAIR	WHITE SINGLE	WHITE PAIR	WT (LBS.)	WATTS	AMP DRAW @ 14VDV	LEDS	*RAW LUMENS	A	B	C	**PEAK BEAM INTENSITY (cd)
HYBRID FLOOD	SM	63311	83311	63411	83411	2.40	44.5	3.18	12	3645	166	129	258	16587
SPECTER DRIVING	SM	63351	83351	63451	83451	2.40	52.8	4.27	18	6615	372	193	386	37203
HYBRID SPOT	SM	63321	83321	63421	83421	2.40	44.5	3.18	12	3645	2027	450	900	202687
SPECTER HYPERSPOT	SM	63341	83341	63441	83441	2.40	44.5	3.18	12	3645	2549	505	1010	254913
HYBRID SPOT/ FLOOD COMBO	SM	63331	83331	63431	83431	2.40	44.5	3.18	12	3645	1346	367	734	134593
SPECTER DRIVING/ HYPERSPOT COMBO	SM	63361	83361	63461	83461	2.40	49.8	3.56	14	4252	1847	430	860	184742

RETROFIT SKUS

HYBRID SPOT	Retrofit	63322	-	-	-	2.00	44.5	3.18	12	3645	2027	450	900	202687
SPECTER HYPERSPOT	Retrofit	63342	-	-	-	2.00	44.5	3.18	12	3645	2549	505	1010	254913
SPECTER DRIVING/ HYPERSPOT COMBO	Retrofit	63362	-	-	-	2.00	49.8	3.56	14	4252	1847	430	860	184742
HYBRID SPOT/ SPECTER HYPERSPOT COMBO	Retrofit	63372	-	-	-	2.00	55.8	3.99	14	4252	1994	447	893	199367

* Raw Lumens is based on LED manufacturer specifications.**Distance with .25 lux and Peak Beam Intensity are tested using ANSI/NEMA FL standards.
(SM) = Surface Mount



LIGHTS COME WITH

BLACK HOUSING SURFACE MOUNT ONLY

- Mounting Hardware
- Stainless Steel, U-Shape Bracket
- Harness w/Switch
- Deutsch Connector
- Solid Black Light Cover

WHITE HOUSING ONLY

- Mounting Hardware
- Stainless Steel, U-Shape Bracket
- Open Leads, No Connector
- Harness Sold Separately
 - PN 40193 (Single)
 - PN 40196 (Pair)

RETROFIT BLACK HOUSING ONLY

- Mounting Hardware
- Built-in Power & Ground Threaded Insert

R-SERIES® 36

Rigid Industries has expanded its round light offering with the new R-Series 36. Designed to be a direct fit into any Par 36 bulb enclosure, this new light is a drop-in replacement for thousands of fixtures used on tractors, heavy equipment, and other industrial and agricultural applications. The Par 36 is also used on many spotlight fixtures. Inside, the R-36 Retrofit is available with Rigid's patented Hybrid or Specter optics in a variety of beam patterns. The lightweight housing includes an advance heat sink for superior cooling, while the outside includes a durable UV-resistant polyester powder coat finish and an unbreakable polycarbonate lens. With its tested resistance to vibration, salt, and water, the Par 36 Retrofit provides years of trouble free use.



**DROP-IN
REPLACEMENT**



FEATURES

- Up to 50,000+ Hour Lifespan
- 9-36 V DC
- Durable UV Polyester Powder Coat
- GORE® Pressure Equalizing Vent
- High-Grade Aluminum Alloy Heatsink
- Integrated Thermal Management System
- Impact Resistant Polycarbonate Lens
- IP68 Compliant - Dust / Water Ingress
- Over / Under Voltage Protection
- Operating Temp -40° F ~ +145° F / -40° C ~ +60° C
- Protected Against RFI / EMI
- Patented Technology
- Reverse Polarity Protection
- RoHS Compliant
- SAE J575 Compliant - Shock / Vibration
- Built-in Power & Ground Threaded Insert
- Through-Hole Heatsink for Optimal Cooling
- Retrofits Standard PAR36 Bulb Enclosure
- Clear Light Cover Included (Light Shown with Cover On)

DIMENSIONS & MOUNTS



PAR36 RETROFIT

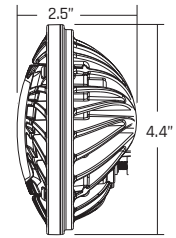
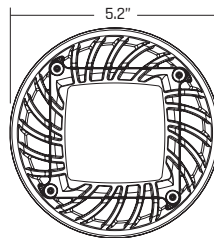

WHAT BEAM
PATTERN WILL
SUIT MY NEEDS
THE BEST?



BEAM PATTERNS

Our custom designed graphs are intended to illustrate the beam patterns that our optics produce. First, consider what type of application the light is needed for and then choose what beam pattern best suits your needs. Each beam pattern varies depending on the optic or optic combination you choose. Once you know which beam pattern best suits your needs, refer to the specifications table (A, B, C) to determine how much LUX output you need and which product will best suit your application.

HYBRID DIFFUSED

Flood optic behind diffused lens

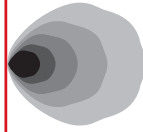

SPECTER DIFFUSED

Driving optic behind diffused lens

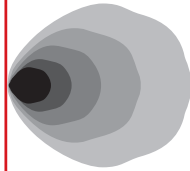

HYBRID FLOOD

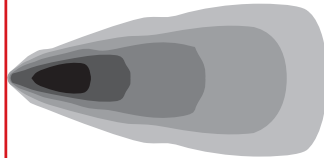

SPECTER DRIVING

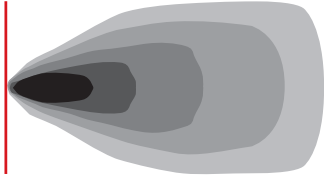

HYBRID SPOT



SPECTER HYPERSPOT



**HOW MUCH
OUTPUT DO
I NEED?**

A = LUX AT 10 METERS
B = BEAM DISTANCE (m) WITH 1 LUX
C = BEAM DISTANCE (m) WITH .25 LUX

SPECIFICATIONS



	MOUNT	BLACK SINGLE	WT. (LBS.)	WATTS	AMP DRAW @ 14VDC	LEDs	*RAW LUMENS	A	B	C	**PEAK BEAM INTENSITY(cd)
HYBRID DIFFUSED	Retrofit	62120	1	24	1.77	4	1411	8	28	57	808
SPECTER DIFFUSED	Retrofit	62150	1	32	2.45	6	2910	19	43	86	1867
HYBRID FLOOD	Retrofit	62130	1	24	1.77	4	1411	33	58	115	3329
SPECTER DRIVING	Retrofit	62140	1	32	2.45	6	2910	145	121	241	14559
HYBRID SPOT	Retrofit	62110	1	24	1.77	4	1411	575	240	480	57542
SPECTER HYPERSPOT	Retrofit	62160	1	23	1.77	4	1411	792	281	563	79178

* Raw Lumens is based on LED manufacturer specifications.**Distance with .25 lux and Peak Beam Intensity are tested using ANSI/NEMA FL standards.



LIGHTS COME WITH

- Mounting Hardware
- Clear Light Cover
- Built-in Power & Ground Threaded Insert

SCENE LIGHTS

Developed specifically for First Responders and Rescue personnel, LED Scene Lighting by Rigid Industries is an efficient way to light up any area. Available in a variety of sizes and configurations to accommodate different needs and uses, Scene Lighting utilizes the latest in LED technology in a rugged housing that incorporates a thermally optimized heat sink for prolonged, trouble-free use. Scene Lights provide up to 115° horizontal spread for maximum coverage and heavy-duty mounting brackets that enable precise adjustable aiming. Whether it's the scene of a fire or a remote pit in Baja, Scene Lighting provides clear, bright light with minimal amp draw.

RIGID's Scene lights are also available with a durable white finish. Though suitable for marine applications, RIGID's white lighting products are perfect for use anywhere an alternative to black is desired. The distinctive white is a durable UV-resistant powder coated finish with an additional chromate conversion coating for superior corrosion resistance. They feature the same legendary lighting technology and superior build quality as the rest of RIGID's lighting products, providing reliable and efficient lighting on demand.

**115°
HORIZONTAL
SPREAD
(2 x 10)**





FEATURES

- 50,000+ Hour Lifespan
- 9-36 V DC
- Durable UV Polyester Powder Coat
- GORE® Pressure Equalizing Vent
- Open Leads for Convenient Wiring
- High-Grade Aluminum Alloy Heatsink
- Integrated Thermal Management System
- Impact Resistant Polycarbonate Lens
- IP68 Compliant - Dust / Water Ingress
- Heavy Duty Brackets Included (Excludes 1 x 2)
- Over / Under Voltage Protection
- Operating Temp -40° F ~ +145° F / -40° C ~ +60° C
- Protected Against RFI / EMI (Excludes 1 x 2)
- Patented Technology
- Reverse Polarity Protection
- RoHS Compliant
- SAE J575 Compliant - Shock / Vibration
- Up to 115° Beam Pattern
- White Polycarbonate Reflector with 98% Reflectivity

DIMENSIONS & MOUNTS

ALL HOUSINGS AVAILABLE IN WHITE



4 x 4

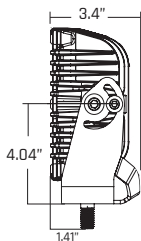
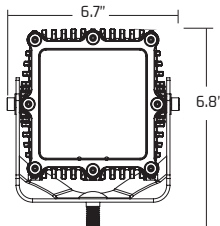

2 x 10

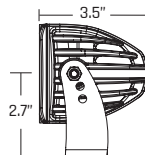
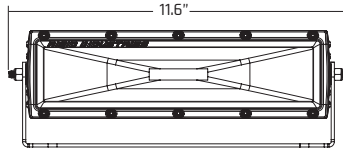

2 x 2

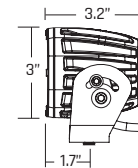
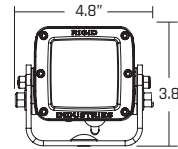

Also available in
Flush Mount

1 x 2

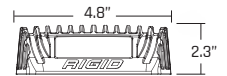

WHAT BEAM
PATTERN WILL
SUIT MY NEEDS
THE BEST?



BEAM PATTERNS

Our custom designed graphs are intended to illustrate the beam patterns that our optics produce. First, consider what type of application the light is needed for and then choose what beam pattern best suits your needs. Each beam pattern varies depending on the optic or optic combination you choose. Once you know which beam pattern best suits your needs, refer to the specifications table (A, B, C) to determine how much LUX output you need and which product will best suit your application.

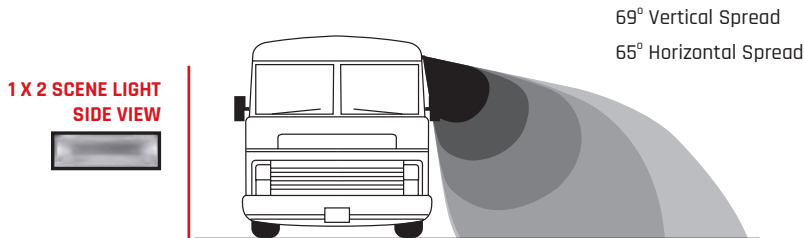
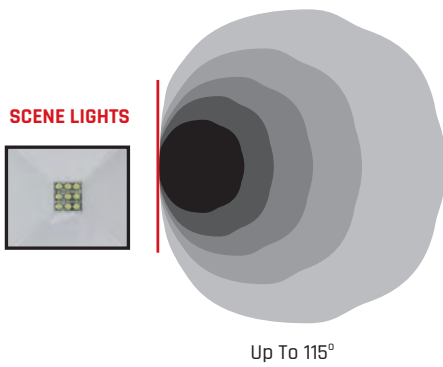

AC ALSO AVAILABLE

ALL HOUSINGS AVAILABLE IN WHITE



HOW MUCH
OUTPUT DO
I NEED?

A = LUX AT 10 METERS
B = BEAM DISTANCE (m) WITH 1 LUX
C = BEAM DISTANCE (m) WITH .25 LUX

SPECIFICATIONS



AC VOLTAGE =114-126 VAC

	BEAM DEGREE	MOUNT	BLACK PART NO	WHITE PART NO.	AC/DC	WT. (LBS.)	WATTS	AMP DRAW	LEDs	*RAW LUMENS	A	B	C	**PEAK BEAM INTENSITY(cd)
1 X 2 SCENE LIGHT	65°	SM	86610	86620	DC	.53	9	.75 @14VDC	3	1100	7	26.4	52.7	695
AMBER - 1 X 2 SCENE LIGHT	65°	SM	86630	86640	DC	.53	9	.75 @14VDC	3	1100	N/A	N/A	N/A	N/A
2 X 2 SCENE LIGHT	115°	SM	68151	68161	DC	2	37	2.78 @14VDC	4	4000	12	35	70	2143
	115°	FM	68152	68162	DC	1.17	37	2.78 @14VDC	4	4000	12	35	70	2143
	115°	FM	68371	68361	AC	2.1	17	.19 @120V	16	1541	8	28	57	797
2 X 10 SCENE LIGHT	115°	SM	68131	68141	DC	5.36	76	6 @14VDC	9	8190	22	47	94	2184
	115°	SM	68351	68341	AC	5.5	76	.79 @120V	80	6293	27	52	104	2702
4 X 4 SCENE LIGHT	115°	SM	68111	68121	DC	5.31	83	5.8 @14VDC	9	8190	22	46	93	2150
	115°	SM	68321	68331	AC	5.1	58	.55 @ 120V	64	6563	24	49	98	2419

* Raw Lumens is based on LED manufacturer specifications. **Distance with .25 lux and Peak Beam Intensity are tested using ANSI/NEMA FL standards.
(SM) = Surface Mount, (FM) = Flush Mount



LIGHTS COME WITH

4 x 4 / 2 x 2 / 2 x 10 HOUSING ONLY

- Mounting Hardware
- Heavy Duty U-Shape Brackets
- Vibration Isolators

1 x 2 HOUSING ONLY

- Mounting Hardware

DC VERSION ONLY

- 2-Wire Open Lead, No Connector

AC VERSION ONLY

- Standard 110V Outlet Plug

SITE SERIES™

Many situations require a highly portable, high-powered light source that can illuminate a required worksite. Whether it's an emergency scene, a mine or industrial application, a remote pit in Baja, or a harbor slip, whatever the situation, RIGID's Site Series provides the flexibility to light any area and provides the mobility to easily move the lighting source with changing conditions. Featuring RIGID's all new 80/40 Optic, Hybrid Flood and an 80/40, Hybrid Spot Combo, the Site Series offers a wider area of coverage than comparable lights from the competition. The Site Series' handle and tilting brackets make adjustments and moving the light easy for the user. Additional mounting options are sold separately. Available in both AC and DC options with a 50,000 hour lifespan and unmatched RIGID quality, the RIGID Site Series provides reliable lighting for many different worksite environments.

RIGID's Site Series lights are also available with a durable white finish. Though suitable for marine applications, RIGID's white lighting products are perfect for use anywhere an alternative to black is desired. The distinctive white is a durable UV-resistant powder coated finish with an additional chromate conversion coating for superior corrosion resistance. They feature the same legendary lighting technology and superior build quality as the rest of RIGID's lighting products, providing reliable and efficient lighting on demand.



**20° SIDE
ANGLE DESIGN
TO INCREASE
BEAM WIDTH**



FEATURES

- 50,000+ Hour Lifespan
- 10-16 V DC, 16-48 V DC, 100-277 V AC
- Durable UV Polyester Powder Coat
- GORE® Pressure Equalizing Vent
- Harness & Switch Included (Exclusions Apply)
- High-Grade Aluminum Alloy Heatsink
- Integrated Thermal Management System
- Impact Resistant Polycarbonate Lens
- IP68 Compliant - Dust / Water Ingress
- Mounting Brackets Included
- Over / Under Voltage Protection
- Operating Temp -40° F ~ +145° F / -40° C ~ +60° C
- Protected Against RFI / EMI
- Patented Technology
- Reverse Polarity Protection
- RoHS Compliant
- SAE J575 Compliant - Shock / Vibration
- Waterproof Deutsch Connector (Exclusions Apply)
- Available in DC & AC Versions
- DC available in Low or High Voltage
- 48 High Quality LEDs
- 20° Side Angle Design for Increased Beam Width
- Various Optic Configuration Options
- Aluminum Clad Printed Circuit Board
- High Quality Aluminum Handle Included to Assist with Aiming or Transporting the Site Light
- Heavy Duty Mounting Bracket with Adjustable Mounting Angles
- Additional Mounting Accessories Available

DIMENSIONS & MOUNTS

ALL HOUSINGS AVAILABLE IN WHITE



SURFACE MOUNT

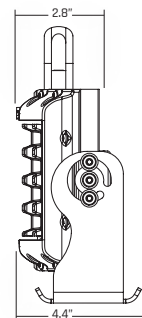
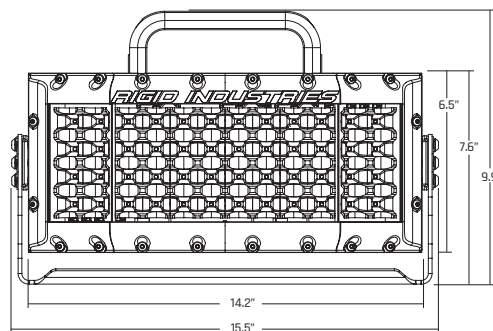

POLE MOUNT ALSO AVAILABLE

Sold Separately - See pg. 131

40095 PART NO.



WHAT BEAM
PATTERN WILL
SUIT MY NEEDS
THE BEST?



BEAM PATTERNS

Our custom designed graphs are intended to illustrate the beam patterns that our optics produce. First, consider what type of application the light is needed for and then choose what beam pattern best suits your needs. Each beam pattern varies depending on the optic or optic combination you choose. Once you know which beam pattern best suits your needs, refer to the specifications table (A, B, C) to determine how much LUX output you need and which product will best suit your application.

HYBRID H350 FLOOD

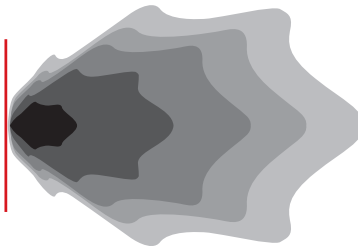

80 / 40

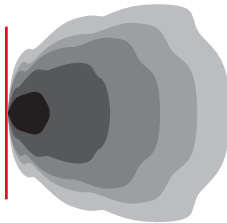

**HYBRID SPOT +
80 / 40 COMBO**

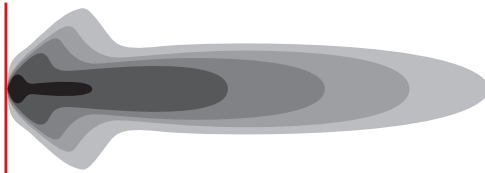

HOW MUCH
OUTPUT DO
I NEED?

A = LUX AT 10 METERS
B = BEAM DISTANCE (m) WITH 1 LUX
C = BEAM DISTANCE (m) WITH .25 LUX

SPECIFICATIONS



	MOUNT	BLACK PART NO.	WHITE PART NO.	VOLTAGE	AC/DC	WT (LBS.)	WATTS	DC-AMP DRAW @14VDC	AC-AMP DRAW @120VAC	LEDS	*RAW LUMENS	A	B	C	**PEAK BEAM INTENSITY (cd)
HYBRID H350 FLOOD	SM	73111	74111	10-16VDC	DC	13.2	283	21.7	-	48	16800	372	203	407	39574
	SM	73311	74311	16-48VDC	DC	13.2	310	22.14	-	48	19200	471	217	434	47129
	SM	73511	74511	100-277VAC	AC	17.4	290	-	2.43	48	19200	471	217	434	47129
80/40	SM	73141	74141	10-16VDC	DC	13.2	283	21.7	-	48	16800	193	139	277	18097
	SM	73341	74341	16-48VDC	DC	13.2	310	22.14	-	48	19200	212	146	291	21215
	SM	73541	74541	100-277VAC	AC	17.4	290	-	2.43	48	19200	212	146	291	21215
HYBRID SPOT + 80/40 COMBO	SM	73131	74131	10-16VDC	DC	13.2	283	21.7	-	48	16800	3511	592	1185	337506
	SM	73331	74331	16-48VDC	DC	13.2	310	22.14	-	48	19200	3734	611	1222	373412
	SM	73531	74531	16-48VDC	DC	13.2	310	22.14	-	48	19200	3734	611	1222	373412

* Raw Lumens is based on LED manufacturer specifications.**Distance with .25 lux and Peak Beam Intensity are tested using ANSI/NEMA FL standards.
(SM) = Surface Mount



LIGHTS COME WITH

- Mounting Hardware
- Stainless Steel, Heavy Duty Adjustable U-Shape Bracket
- Vibration Isolators

AC VERSION ONLY

- Power Supply with Standard 110V Outlet Plug
- Deutsch Connector (Both Light & Power Supply)

DC VERSION ONLY

- 2-Wire Open Leads, No Connector

RI-SERIES™

The Rigid Industries RI-Series is a full line of flashlights that offer high-output LED technology in a compact package. Inspired by tactical flashlights developed for military and law enforcement, the RI-Series couples cutting edge LEDs with machined aluminum reflectors to create a rugged, powerful light source. With a military-grade hard anodized aluminum housing, waterproof construction, rechargeable battery, and many more features, the RI-Series can withstand the elements and provide years of trouble-free operation.



LIGHTS COME WITH

- Anti-Roll
- Pocket Clip (Excludes RI-600)
- Lanyard
- AC/DC Car Charger
- 110 Volt Wall Charger
- Rechargeable Lithium Ion Battery(s)
 - (1) RI-600 & RI-800
 - (2) RI-1100 & RI-1500

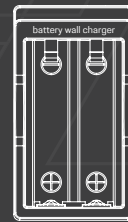
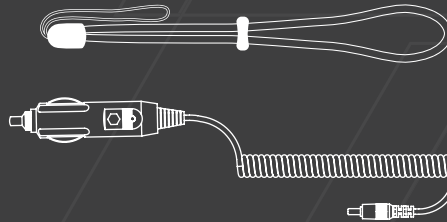

**THE POWER
OF RIGID IN
YOUR
HANDS**



FEATURES

- 50,000+ Hour Lifespan
- Impact Resistant Polycarbonate Lens
- IP67 Compliant - Dust / Water Ingress
- Operating Temp -40° F - +145° F / -40° C - +60° C
- RoHS Compliant
- SAE J575 Compliant - Shock / Vibration
- High, Medium, Low, And Strobe Modes
- High Intensity Spot Reflector Design
- Thermally Regulated LED Circuit
- Momentary Tail-Cap Switch
- Type 3 Military Grade Hard Anodized Aluminum
- Polished Aluminum Reflector
- RI-600 is Available in Red, Blue, Green, Infrared and UV LEDs
- Tactical Bezel Housing (Excludes RI-600)
- Textured Pattern On Handle For Grip
- Works with 18650 Li-Ion or CR123 Batteries
- Limited Lifetime Warranty
- Holsters Also Available (Sold Separately)



DIMENSIONS



RI-600



RI-800



RI-1100



RI-1500

PART #	LIGHT COLOR OPTION
30130	Cool White
30132	Red
30133	Green
30134	Blue
30135	Semi-UV
30136	Infrared

SPECIFICATIONS



PART NO.	MODE	*RAW LUMENS	EFFECTIVE LUMENS	BATTERY RUN TIME	LUX @ 10mV	BEAM DISTANCE (m) w/1 LUX	**PEAK BEAM INTENSITY (cd)
30130 (Cool White)	HIGH	680	620	1.8 hrs	69	165	6945
	MED	250	210	6.5 hrs	27	104	2710
	LOW	80	60	24 hrs	7	51	669
30140 (Cool White)	HIGH	820	768	1.6 hrs	231	304	23174
	MED	300	273	5.5 hrs	95	195	9560
	LOW	100	81	18 hrs	27	105	2740
30150 (Cool White)	HIGH	1100	960	2.1 hrs	253	318	25340
	MED	300	273	9 hrs	95	195	9560
	LOW	100	81	26 hrs	27	105	2740
30160 (Cool White)	HIGH	1500	1340	1.2 hrs	602	490	60202
	MED	475	412	3.7 hrs	224	299	22476
	LOW	150	104	16.5 hrs	51	146	5167

* Raw Lumens is based on LED manufacturer specifications. **Distance with .25 lux and Peak Beam Intensity are tested using ANSI/NEMA FL standards.

Truck-Lite[®] **LED HEADLIGHT KIT** BY RIGID INDUSTRIES[®]

Truck-Lite[®] Headlight Kits by Rigid Industries are an excellent upgrade for light, medium and heavy-duty trucks, off-road vehicles, classic cars, motorcycles and more. Perfectly adapted to cold environments, the 7" Round Heated Lens provides a steady, complete-surface melting of snow and ice that is only active when temperatures drop under 50°F/10°C. Metalized reflector optics provide lighting that is smooth and clean across the entire driving surface. LED headlights provide a brighter, crisper and whiter light output as compared to traditional incandescent, halogen, or HID headlights, with a color temperature closer to daylight. The advantages of LED lighting technology result in dramatically improving light projection distance and overall visibility. The durability and dependability of LED lighting provides a solid-state, bulb-free headlamp design that is impervious to damage from shock and vibration.



**THE PERFECT
COMBINATION FOR
TRAVELING FAR
AND WIDE.**



FEATURES

- DOT Compliant
- 16-Gauge Wire
- Encapsulated Circuitry
- 2 LED Arrays
- Low & High Beams
- Hard-Coated Polycarbonate Lens
- E-Coat Aluminum Housing
- Metalized Reflectors

SPECIFICATIONS



Heated Lens
Turns On At 10°C/50°F

	SINGLE PART NO	PAIR PART NO	WT (LBS.)	WATTS	LEDs	AMP DRAW HEATED OFF @ 12.8VDC	AMP DRAW HEATED ON @ 12.8VDC
7" Round w/ PWM Adaptors	-	55000	2	46 / 23	2	3.0 / 5.6	7.6 / 10.6
7" Round w/ H13 to H4 Adaptors	-	55001	2	46 / 23	2	3.0 / 5.6	7.6 / 10.6
7" Round Single	55002	-	2	46 / 23	2	3.0 / 5.6	7.6 / 10.6
5" x 7" No Adaptor	-	55003	2	46 / 23	2	3.0 / 5.6	7.6 / 10.6
7" Round Heated Lens w/PWM Adaptor	-	55004	2	46 / 23	2	3.0 / 5.6	7.6 / 10.6
7" Round Heated Lens w/ H13 to H4 Adaptor	-	55005	2	46 / 23	2	3.0 / 5.6	7.6 / 10.6
LED HL PWM Anti-Flicker Adaptor - H13 to H4	55006	-	2	46 / 23	2	3.0 / 5.6	7.6 / 10.6
7" Round Heated Lens Non JK No Adaptor	-	55008	2	46 / 23	2	3.0 / 5.6	7.6 / 10.6
7" Round Lens Non JK No Adaptor	-	55009	2	46 / 23	2	3.0 / 5.6	7.6 / 10.6

E-MARK COMPLIANT E₁₁

RIGID's worldwide expansion means addressing the needs of customers in a global marketplace, including those that need lighting that complies with European standards. For these users, RIGID now offers E-Mark Compliant Lights (ECE). The E-Mark Compliance is a widely recognized mark in the automotive industry covering the safety requirements of automotive vehicles and their components across Europe.



FEATURES

- 50,000+ Hour Lifespan
- 9-36 V DC
- Durable UV Polyester Powder Coat
- GORE® Pressure Equalizing Vent
- Harness & Switch Included (Exclusion May Apply)
- High-Grade Aluminum Alloy Heatsink
- Integrated Thermal Management System
- Impact Resistant Polycarbonate Lens
- IP68 Compliant - Dust / Water Ingress
- Mounting Brackets Included
- Over / Under Voltage Protection
- Operating Temp -40° F ~ +145° F / -40° C ~ +60° C
- Protected Against RFI / EMI



- Patented Technology
- Reverse Polarity Protection
- RoHS Compliant
- SAE J575 Compliant - Shock / Vibration
- Waterproof Deutsch Connector (Exclusions May Apply)



SPECIFICATIONS

A = LUX AT 10 METERS

B = BEAM DISTANCE (m) WITH 1 LUX

C = BEAM DISTANCE (m) WITH .25 LUX

	SERIES/ SIZE	SINGLE PART NO	PAIR PART NO	MAX LUM INTENSITY#	CLASS	WT. (LBS.)	WATTS	AMP DRAW @ 14VDC	LEDs	*RAW LUMENS				**PEAK BEAM INTENSITY (cd)
											A	B	C	
ECE SPECTER DRIVING	SR (10")	910612EM	911612EM	7.5	A	2.50	52.4	3.8	15	5625	290	170	341	29000
	SR (20")	92161EM	-	12.5	A	5.43	120.1	7.61	30	11250	685	262	523	68500
	E (6")	17561EM	17661EM	7.5	A	2.35	67.5	4.89	18	6750	360	190	379	36000
	E (10")	17861EM	17961EM	10	A	3.45	75	5.43	30	9000	482	220	439	48200
	E (20")	12161EM	-	17.5	B	6.15	162	11.8	60	18000	867	294	589	86700
	Q	54431EM	-	12.5	A	2.8	69	4.9	24	9000	360	190	379	35987
ECE HYBRID SPOT	D-SERIES	20121EM	20221EM	17.5	B	1.10	15.8	1.1	4	1568	646	254	508	64600
	SR (6")	906212EM	907212EM	17.5	B	1.78	23.5	1.7	6	2250	730	270	540	73000
	SR (10")	910212EM	911212EM	30	B	2.5	35.9	2.6	10	3750	1290	359	718	129000
	E (4")	104212EM	104312EM	27.5	B	1.90	30	2.17	8	3000	1111	333	667	11100
	E (6")	106212EM	106312EM	37.5	B	2.35	45	3.26	12	4500	1750	418	837	17500
	SR-Q	-	90521EM	10	B	.75	15	1.1	4	1568	458	214	428	17500
ECE HYBRID SPOT FLOOD COMBO	SR (20")	92031EM	-	37.5	B	2.72	75.9	5.5	20	7500	1750	418	837	175000
	E (10")	110312EM	110412EM	30	B	3.45	65	4.71	20	5740	1500	387	775	150000

* Raw Lumens is based on LED manufacturer specifications. ** Distance with .25 lux and Peak Beam Intensity are tested using ANSI/NEMA FL standards.



BEAM PATTERNS

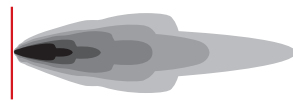
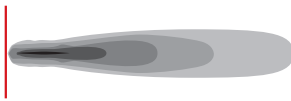

SAE COMPLIANT

Off-road auxiliary lighting is one thing, but everyone knows that it's important to have lighting that is also safe and legal for on-road use. RIGID's SAE Compliant Fog Lights and Auxiliary High Beam Driving Lights allow them to be used on-the-road and not just off-road. RIGID created the proprietary output spread and height with the new patented Clarilux™ optic system. The color temperature of these LEDs was carefully chosen to be a perfect range of pure daylight to penetrate the night for superior clarity on the road. These SAE Compliant lights project long-range high intensity light while drawing very little power and provide up to 50,000 useful hours.



FEATURES

- 50,000+ Hour Lifespan
- 9-36 V DC
- Durable UV Polyester Powder Coat
- GORE® Pressure Equalizing Vent
- Harness & Switch Included (Exclusions May Apply)
- High-Grade Aluminum Alloy Heatsink
- Integrated Thermal Management System
- Impact Resistant Polycarbonate Lens
- IP68 Compliant - Dust / Water Ingress
- Mounting Brackets Included
- Over / Under Voltage Protection
- Operating Temp -40° F ~ +145° F / -40° C ~ +60° C
- Protected Against RFI / EMI
- Patented Technology
- Reverse Polarity Protection
- RoHS Compliant
- SAE J575 Compliant - Shock / Vibration
- Waterproof Deutsch Connector (Exclusions May Apply)
- Fog Light is Compliant with SAEJ583
- Auxiliary High Beam Driving Light Compliant with SAE J581



A = LUX AT 10 METERS

B = BEAM DISTANCE (m) WITH 1 LUX

C = BEAM DISTANCE (m) WITH .25 LUX

SPECIFICATIONS



	SERIES/SIZE	BLACK PAIR	WT. (LBS.)	WATTS	AMP DRAW @ 14VDC	LEDs	*RAW LUMENS	A	B	C	**PEAK BEAM INTENSITY (cd)
FOG LIGHT	D-SERIES	50481	1.10	22	1.5	4	1760	106	103	206	10570
FOG LIGHT	SR-SERIES	90670	1.78	21	1.5	6	2640	130	114	228	13030
DRIVING AUXILIARY HIGH BEAM	E-SERIES (6")	106612	2.35	41	2.85	12	5280	492	222	444	49230

* Raw Lumens is based on LED manufacturer specifications. ** Distance with .25 lux and Peak Beam Intensity are tested using ANSI/NEMA FL standards. SPECIFICATIONS ARE DISPLAYED PER SINGLE LIGHT

BEAM PATTERNS



Our custom-designed LUX graphs shown below visually demonstrate the distinct beam pattern created by each optic.

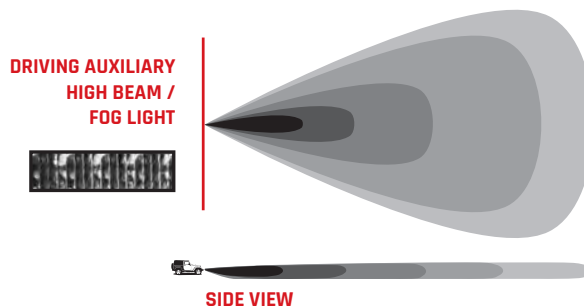

HIGH & LOW

Not all situations require the same light intensity. Rigid Industries High & Low Dual Function LED Lights provide the flexibility to adjust the lighting to the conditions with the flip of a switch. These lights feature a three-wire harness, and the High, Low, or Off three-position rocker switch gives the user an option to run at full intensity on High power, or 20% intensity on Low power. The Rigid Industries High & Low Dual Function LED Lights feature a thermally engineered oversized heat sink to provide superior cooling power and a 50,000-hour lifespan. If one-size-fits-all lighting does not work for your needs, then the Rigid High & Low Function LED Lights are the perfect choice for adapting to changing conditions.

RIGID's High & Low lights are also available with a durable white finish. Though suitable for marine applications, RIGID's white lighting products are perfect for use anywhere an alternative to black is desired. The distinctive white is a durable UV-resistant powder coated finish with an additional chromate conversion coating for superior corrosion resistance. They feature the same legendary lighting technology and superior build quality as the rest of RIGID's lighting products, providing reliable and efficient lighting on demand.



**SWITCH
CONDITIONS
AT A FLIP OF
A SWITCH**



FEATURES

- 50,000+ Hour Lifespan
- 9-36 V DC
- Durable UV Polyester Powder Coat
- GORE® Pressure Equalizing Vent
- Harness & Switch Included (Exclusions May Apply)
- High-Grade Aluminum Alloy Heatsink
- Integrated Thermal Management System
- Impact Resistant Polycarbonate Lens
- IP68 Compliant - Dust / Water Ingress
- Mounting Brackets Included
- Over / Under Voltage Protection
- Operating Temp -40° F ~ +145° F / -40° C ~ +60° C
- Protected Against RFI / EMI
- Patented Technology
- Reverse Polarity Protection
- RoHS Compliant
- SAE J575 Compliant - Shock / Vibration
- Waterproof Deutsch Connector (Exclusions May Apply)
- Specter Optics
- Dual Function LED Lights
- 3-Position Rocker Switch Included
- Same High Output With an Added Courtesy Mode

A = LUX AT 10 METERS

B = BEAM DISTANCE (m) WITH 1 LUX

C = BEAM DISTANCE (m) WITH .25 LUX

HIGH / LOW (20% of High Output)

HOUSINGS AVAILABLE IN WHITE

SPECIFICATIONS



SPECTER DRIVING

SERIES/ MOUNT	BLACK SINGLE	BLACK PAIR	WT. (LBS.)	WATTS	AMP DRAW @14VDC	LEDs	*RAW LUMENS	A	B	C	**PEAK BEAM INTENSITY(cd)
D (SM)	50131H	50231H	1.1	34.5 / 8	2.5 / 0.6	6	3096 / 607	203 / 40	142 / 28	285 / 56	20300 / 3979
D (FM)	51131H	51231H	1.17	34.5 / 8	2.5 / 0.6	6	3096 / 607	203 / 40	142 / 28	285 / 56	20300 / 3979
SR-M (SM)	91231H	-	0.38	11 / 2.6	0.8 / 0.2	3	1125 / 221	77.4 / 15	88 / 17	176 / 34	7740 / 1517
SR-M (FM)	93231H	-	0.45	11 / 2.6	0.8 / 0.2	3	1125 / 221	77.4 / 15	88 / 17	176 / 34	7740 / 1517
SR-Q (SM)	91431H	91531H	0.75	34.5 / 8	2.5 / 0.6	6	3096 / 607	203 / 40	142 / 28	285 / 56	20300 / 3979
SR-Q (FM)	93431H	93531H	0.9	34.5 / 8	2.5 / 0.6	6	3096 / 607	203 / 40	142 / 28	285 / 56	20300 / 3979
SR (6")	90661H	-	1.4	30.4 / 7	2.2 / 0.5	9	3375 / 662	210 / 41	145 / 28	290 / 57	21000 / 4116
SR (10")	91061H	-	2.72	52.4 / 12.2	3.8 / 0.9	15	5625 / 1103	290 / 57	170 / 33	341 / 67	29000 / 5684
E (4")	17361H	-	1.9	45 / 10.4	3.26 / 0.7	12	4500 / 882	260 / 51	161 / 32	322 / 63	26000 / 5096
E (6")	17561H	-	2.3	67.5 / 15.7	4.89 / 1.1	18	6750 / 1323	360 / 71	190 / 37	379 / 74	36000 / 7056
E (10")	17861H	-	3.45	75 / 17.4	5.43 / 1.2	30	9000 / 1764	482 / 94	220 / 43	439 / 86	48200 / 9447

SPECTER DIFFUSED

SERIES/ MOUNT	WHITE SINGLE	WHITE PAIR	WT. (LBS.)	WATTS	AMP DRAW @14VDC	LEDs	*RAW LUMENS	A	B	C	**PEAK BEAM INTENSITY(cd)
SR-M (SM)	95251H	-	0.38	11 / 2.6	0.8 / 0.2	3	1125 / 221	11.3 / 2	34 / 7	67 / 13	1130 / 221
SR-M (FM)	97251H	-	0.45	11 / 2.6	0.8 / 0.2	3	1125 / 221	11.3 / 2	34 / 7	67 / 13	1130 / 221
SR-Q (SM)	95451H	95551H	0.75	34.5 / 8	2.5 / 0.6	6	3096 / 607	20 / 4	45 / 9	89 / 17	2000 / 392
SR-Q (FM)	97451H	97551H	0.9	34.5 / 8	2.5 / 0.6	6	3096 / 607	20 / 4	45 / 9	89 / 17	2000 / 392

* Raw Lumens is based on LED manufacturer specifications.**Distance with .25 lux and Peak Beam Intensity are tested using ANSI/NEMA FL standards.
(SM) = Surface Mount, (FM) = Flush Mount

AMBER & WHITE

DUAL FUNCTION E-SERIES

RIGID's Amber & White Dual Function LED Lights meet changing conditions with just one light bar. These lights feature a top row of amber LEDs and bottom row of white LEDs, all of which is controlled with a three-position rocker switch. Amber lights work best in murky conditions such as fog, dust, and smoke, while white lights are best for projecting light long distances. The Dual Function LED Lights are available in a 20" housing and allow the user to toggle between amber and white light with the flip of a switch.

★ FEATURES

- 50,000+ Hour Lifespan
- 9-36 V DC
- Durable UV Polyester Powder Coat
- GORE® Pressure Equalizing Vent
- Harness & Switch Included (Exclusions Apply)
- High-Grade Aluminum Alloy Heatsink
- Integrated Thermal Management System
- Impact Resistant Polycarbonate Lens
- IP68 Compliant - Dust / Water Ingress
- Mounting Brackets Included
- Over / Under Voltage Protection
- Operating Temp -40° F ~ +145° F / -40° C ~ +60° C
- Protected Against RFI / EMI



- Patented Technology
- Reverse Polarity Protection
- RoHS Compliant
- SAE J575 Compliant - Shock / Vibration
- Waterproof Deutsch Connector (Exclusions Apply)
- Switch-Controlled-Modes: Amber or White
- Amber 550 - 590 NM Wavelengths, Helps Cut through the Elements

☰ SPECIFICATIONS

A = LUX AT 10 METERS
 B = BEAM DISTANCE (m) WITH 1 LUX
 C = BEAM DISTANCE (m) WITH .25 LUX

AMBER & WHITE HYBRID FLOOD/ SPOT COMBO

SIZE	PART NO.	WT. (LBS.)	WATTS	AMP DRAW @ 14VDC	LEDs	*RAW LUMENS	A	B	C	**PEAK BEAM INTENSITY(cd)
20"	120312AW	6.15	80	5.56	40	6620	2127	499	1000	212782
28"	128312AW	7.9	112	7.78	56	9268	2347	524	1048	234788
30"	130312AW	8.85	120	8.33	60	9930	2678	560	1121	267798
38"	138312AW	11.1	152	10.56	76	12578	3216	611	1222	321582
40"	140312AW	11.55	160	11.11	80	13240	4022	687	1375	402259
50"	150312AW	14.25	200	13.89	100	16550	4604	734	1470	460437

* Raw Lumens is based on LED manufacturer specifications. **Distance with .25 lux and Peak Beam Intensity are tested using ANSI/NEMA FL standards. A, B, C Lux Reading only apply to white light, not applicable to amber lights.

☐ BEAM PATTERNS

AMBER & WHITE HYBRID FLOOD /SPOT COMBO



AMBER



WHITE



AMBER LIGHTS

Amber light has long been known to be more effective in murky conditions, including fog, extreme dust, and smoke. Desert racers have adopted Amber lighting as a better option to traditional white light when chasing down vehicles ahead of them. First responders appreciate having a dedicated amber lighting option when conditions render white light less effective. As a result, we offer dedicated Amber light bars to fill these needs and those of any application where conventional light is obstructed by adverse conditions.



FEATURES

- 50,000+ Hour Lifespan
- 9-36 V DC
- Durable UV Polyester Powder Coat
- GORE® Pressure Equalizing Vent
- Harness & Switch Included (Exclusions Apply)
- High-Grade Aluminum Alloy Heatsink
- Integrated Thermal Management System
- Impact Resistant Polycarbonate Lens
- IP68 Compliant - Dust / Water Ingress
- Mounting Brackets Included
- Over / Under Voltage Protection
- Operating Temp -40° F ~ +145° F / -40° C ~ +60° C



- Protected Against RFI / EMI
- Patented Technology
- Reverse Polarity Protection
- RoHS Compliant
- SAE J575 Compliant - Shock / Vibration
- Waterproof Deutsch Connector (Exclusions Apply)
- Instant On / Off - No Warm Up

D-SERIES AMBER LIGHTS



HYBRID SPOT

MOUNT	SINGLE PART #	PAIR PART #
SM	20122	20222
FM	21122	21222
HD	22122	22222
Y/HD	23122	23222
SM	50132	50232
FM	51132	51232
HD	52132	52232
Y/HD	53132	53232

SPECTER DRIVING

SR-M AMBER LIGHTS



HYBRID SPOT

MOUNT	SINGLE PART #
SM	90222
FM	92222
SM	91232
FM	93232
SM	91252
FM	93252

SPECTER DRIVING

SPECTER DIFFUSED

SR-Q AMBER LIGHTS



HYBRID SPOT

MOUNT	SINGLE PART #	PAIR PART #
SM	90422	90522
FM	92422	92522
SM	91432	91532
FM	93432	93532

SPECTER DRIVING

E-SERIES AMBER LIGHTS



HYBRID SPOT

SIZE	SINGLE PART #
4"	104222
6"	106222
10"	110222
20"	120222
30"	130222
40"	140222
50"	150222
6"	106322
10"	110322
20"	120322
28"	128322
30"	130322
38"	138322
40"	140322
50"	150322

HYBRID SPOT/ FLOOD COMBO

SR-SERIES AMBER LIGHTS



HYBRID SPOT

SIZE	SINGLE PART #
6"	906222
10"	910222
6"	906322
10"	910322
20"	92032
30"	93032
40"	94032
50"	95032
6"	906522
10"	910522

HYBRID SPOT/ FLOOD COMBO

SPECTER DRIVING

(SM) = Surface Mount, (FM) = Flush Mount, (HD) = All Black Heavy Duty, (Y/HD) = Yellow Heavy Duty

MIL-STD-461F EMI COMPLIANT

RIGID's MIL-STD-461F Compliant lights meet stringent military standards and are designed to withstand the harshest work environments. Using RIGID's forward projecting LED lighting technology, the patented optics capture the maximum amount of light emitted from the individual LEDs, creating a brilliant white light that delivers a reliable 50,000 hour lifespan. When lighting options demand military-grade reliability, the MIL-STD-461F EMI Compliant light is the total lighting solution.



FEATURES

- 50,000+ Hour Lifespan
- 9-36 V DC
- Durable UV Polyester Powder Coat
- GORE® Pressure Equalizing Vent
- Harness & Switch Included (Exclusions Apply)
- High-Grade Aluminum Alloy Heatsink
- Integrated Thermal Management System
- Impact Resistant Polycarbonate Lens
- IP68 Compliant - Dust / Water Ingress
- Mounting Brackets Included
- Over / Under Voltage Protection



- Operating Temp -40° F ~ +145° F / -40° C ~ +60° C
- Protected Against RFI / EMI
- Patented Technology
- Reverse Polarity Protection
- RoHS Compliant
- SAE J575 Compliant - Shock / Vibration
- Waterproof Deutsch Connector (Exclusions Apply)



SPECIFICATIONS

A = LUX AT 10 METERS

B = BEAM DISTANCE (m) WITH 1 LUX

C = BEAM DISTANCE (m) WITH .25 LUX

	SERIES SIZE/MOUNT	SINGLE PART NO.	PAIR PART NO.	WT (LBS.)	WATTS	AMP DRAW @ 14VDC	LEDs	RAW LUMENS	A	B	C	PEAK BEAM INTENSITY(ccd)
SPECTER DIFFUSION	D (HD)	52151MIL	-	1.40	34.5	2.40	6	3096	22	47	94	2200
	D (HD)	-	52251MIL	2.80	34.5	2.40	6	6192	41	64	128	4118
HYBRID FLOOD	E (6")	106112MIL	-	2.35	45	3.13	12	4500	156	125	250	15615
	E (10")	110112MIL	-	3.45	75	5.21	20	5740	237	154	308	23968
SPECTER DRIVING	D (HD)	52131MIL	-	1.40	34.5	2.40	6	3096	166	129	258	16586
	D (HD)	-	52231MIL	2.80	34.5	2.40	6	6192	304	174	349	30370
SPECTER WIDE	D (HD)	52111MIL	-	1.40	34.5	2.40	6	3096	180	134	269	18031
	D (HD)	-	52211MIL	2.80	34.5	2.40	6	6192	289	170	340	28921
HYBRID SPOT	E (6")	106212MIL	-	2.35	45	3.13	12	4500	1612	402	803	161198
	E (10")	110212MIL	-	3.45	75	5.21	20	5740	2460	496	992	245953
HYBRID FLOOD/ SPOT COMBO	E (6")	106312MIL	-	2.35	45	3.13	12	4500	687	262	524	68668
	E (10")	110312MIL	-	3.45	62	4.31	20	5740	1756	419	838	175555

* Raw Lumens is based on LED manufacturer specifications. **Distance with .25 lux and Peak Beam Intensity are tested using ANSI/NEMA FL standards. (HD) = All Black Heavy Duty



BEAM PATTERN

**SPECTER
DIFFUSED**



Driving optic behind diffused lens

**HYBRID
FLOOD**



**SPECTER
DRIVING**



**SPECTER
WIDE**



**HYBRID
SPOT**



**HYBRID FLOOD /
SPOT COMBO**



INFRARED LIGHTS

Certain applications require a stealthy light source, and the Infrared LED Lights by RIGID offers an excellent solution. RIGID combines special LED lighting configurations and optics to provide a high-powered infrared light source that brings stealth to a new level. These infrared lights produce a beam of energy at 940 nanometers, which is considered invisible light. These lights are useful for enhancing night vision ability for military personnel, public safety, security services, and many other applications that utilize infrared technology.



FEATURES

- 50,000+ Hour Lifespan
- 9-36 V DC
- Durable UV Polyester Powder Coat
- GORE® Pressure Equalizing Vent
- Harness & Switch Included (Exclusions Apply)
- High-Grade Aluminum Alloy Heatsink
- Integrated Thermal Management System
- Impact Resistant Polycarbonate Lens
- IP68 Compliant - Dust / Water Ingress
- Mounting Brackets Included
- Over / Under Voltage Protection
- Operating Temp -40° F ~ +145° F / -40° C ~ +60° C
- Protected Against RFI / EMI
- Patented Technology
- Reverse Polarity Protection
- RoHS Compliant
- SAE J575 Compliant - Shock / Vibration
- Waterproof Deutsch Connector (Exclusions Apply)
- 940 nm Infrared Illuminated beam
- Tinted CR-39® Lens to Eliminate all Reflective Surfaces within the Housing



SPECIFICATIONS



	SERIES SIZE	SINGLE PART NO.	PAIR PART NO.	WEIGHT (LBS.)	WATTS	AMP DRAW @ 14VDC	LEDs	RAW LED MW OUTPUT	E-lm OUTPUT	E-cd
HYBRID SPOT	D-SERIES	20129	20229	1.1	17.5	1.25	4	3960	1584	64200
SPECTER DRIVING	D-SERIES	50139	50239	1.1	32.2	2.3	6	5940	2376	13376
HYBRID FLOOD/ SPOT COMBO	SR (10")	91039	-	2.72	34.5	2.46	10	9900	3960	89760
	E (4")	104392	-	1.9	35.8	2.56	8	7920	3168	43648
	E (10")	110392	-	3.45	46	3.28	20	19800	7920	206968

E-lm - Lumen Equivalent / E-cd - Candela Equivalent

NIGHT VISION



NIGHT VISION WITH INFRARED LIGHT



LIGHTING KITS

pg **107** - pg **110**

BRANDON PALANIUK SIGNATURE SERIES BOAT DECK LIGHT KITS

Created specifically for night fishing, Rigid Industries' Boat Deck Lighting Kit provides a simple and effective way to illuminate boat decks for night use without blinding boat occupants. These kits consist of four or six A-Series lights with a dedicated 27' harness that can handle most installations on boats of up to 24'. The A-Series LED lights feature water resistant die cast aluminum housings, polycarbonate lens and a built-in thermal management system that ensures long life. These kits are also available in a variety of colors and color combinations to accommodate different needs and preferences.



FEATURES

- 50,000+ Hour Lifespan
- 9-24 V DC
- Durable UV Polyester Powder Coat
- High-Grade Aluminum Alloy Heatsink
- Integrated Thermal Management System
- Impact Resistant Polycarbonate Lens
- IP68 Compliant - Dust / Water Ingress
- Over / Under Voltage Protection
- Op. Temp -40° F ~ +145° F / -40° C ~ +60° C
- Protected Against RFI / EMI
- Patented Technology
- Reverse Polarity Protection
- RoHS Compliant
- SAE J575 Compliant - Shock / Vibration
- Custom Wiring Harness (Up to 24' Fishing Boat)
- Available in 4 and 6 Light Options
- Multiple Color Choices



SPECIFICATIONS



	LIGHT COLOR	KIT PART NO.	WATTS	AMP DRAW @ 14VDC	LEDs	*RAW LUMENS	Number of Distribution Blocks	Number of Switches
4 LIGHT KIT	Cool White	40076	16	0.8	12	800	1	1
	Blue	40077	16	0.8	12	800	1	1
	Red	40078	16	0.8	12	800	1	1
	Green	40079	16	0.8	12	800	1	1
	Amber	40080	16	0.8	12	800	1	1
	(2) White, (2) Blue	40081	16	0.8	12	800	2	2
	(2) White, (2) Red	40082	16	0.8	12	800	2	2
	(2) White, (2) Green	40083	16	0.8	12	800	2	2
	(2) White, (2) Amber	40084	16	0.8	12	800	2	2
6 LIGHT KIT	Cool White	40085	24	1.2	18	1200	1	1
	Blue	40086	24	1.2	18	1200	1	1
	Red	40087	24	1.2	18	1200	1	1
	Green	40088	24	1.2	18	1200	1	1
	Amber	40089	24	1.2	18	1200	1	1
	(2) White, (4) Blue	40090	24	1.2	18	1200	2	2
	(2) White, (4) Red	40091	24	1.2	18	1200	2	2
	(2) White, (4) Green	40092	24	1.2	18	1200	2	2
	(2) White, (4) Amber	40093	24	1.2	18	1200	2	2



KIT INCLUDES

- (4) or (6) A-Series w/ 15' Leads
- Distribution Block(s) for Easy Wiring
- 27' Wiring Harness w/ Fuse & Switch
- Mounting Hardware
- 3 Amp Blade Fuses (4 or 6)
- 1 or 2 Switches (1 or 2 Colors)

IGNITE™ MOTORCYCLE KITS

Rigid's Ignite is compact yet powerful, packing 1000 raw lumens in a housing that measures just 1.4" x 1.4" x 2" and weighs less than 4 ounces. Each Ignite Light also consumes just 1 amp at full power. The Motorcycle Kits have both High and Low settings that enable the lights to easily work with a sealed control switch suitable for permanently mounting the lights just about anywhere on the bike. With the Ignite Motorcycle Kit, it's easier than ever to add lights to touring bikes, cruisers, dirt bikes, and just about any other application.



FEATURES

- Small Package, Big Output
- IP68 Compliant
- Rigid Quality & Performance
- Unlimited Mounting Options
- (Surface Mount);
Mates To Any Go-Pro® Case Mount
- Using 1.75" Hole saw
- Low Minimum Voltage; 6-28 VDC
- 2 Outputs; High & Low
- See pg. 34 for Additional Features



DIMENSIONS & MOUNTS

SURFACE MOUNT

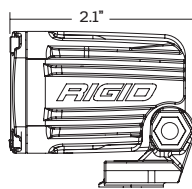
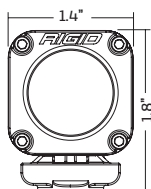

A = LUX AT 10 METERS
 B = BEAM DISTANCE (m) WITH 1 LUX
 C = BEAM DISTANCE (m) WITH .25 LUX



SPECIFICATIONS HIGH / LOW

	MOUNT	KIT PART NO.	WT. (OZ)	WATTS	AMP DRAW @ 14VDC	LEDs	*RAW LUMENS	A	B	C	**PEAK BEAM INTENSITY(cd)
HYBRID FLOOD	SM	20741	3.8	12 / 2	0.85 / 0.14	1	1000 / 200	139 / 43	118 / 43	236 / 87	13939 / 1895
HYBRID SPOT	SM	20731	3.8	12 / 2	0.84 / 0.14	1	1000 / 200	18 / 2	42 / 11	80 / 23	1786 / 239



KIT INCLUDES

- 2 Ignite Lights High / Low Lights
- 2 Sets of Hardware
- 2 Mounting Brackets
- 1 Wiring Harness & Switch

IGNITE™ BACK-UP KITS

Most vehicles have very inadequate backup lighting, which can be a major safety problem. Rigid makes it easy to add compact and powerful backup lighting to any vehicle with the Rigid Ignite™ Backup Kit. The Ignite Series Accessory Lights are small but pack a lot of power with 1000 raw lumens in a light that measures just 1.4" x 1.4" x 2". While a wiring harness is not included, the powerful LEDs in each light consume less than one amp each, so powering them is often as easy as tapping into the vehicle's existing backup lighting circuit.



FEATURES

- Small Package, Big Output
- IP68 Compliant
- RIGID Quality & Performance
- Unlimited Mounting Options
- (Surface Mount);
Mates To Any Go-Pro® Case Mount
- Easy (Flush Mount) Install
- Using 1.75" Hole saw
- Low Minimum Voltage; 6-28 VDC
- See pg. 34 for Additional Features



DIMENSIONS & MOUNTS



SURFACE MOUNT

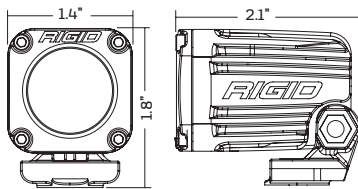

FLUSH MOUNT

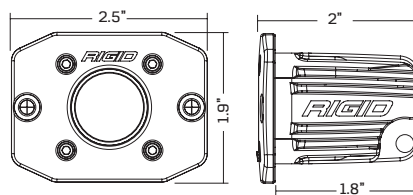

SPECIFICATIONS



	MOUNT	KIT PART NO.	WT. (OZ)	WATTS	AMP DRAW @ 14VDC	LEDs	*RAW LUMENS	A	B	C	**PEAK BEAM INTENSITY(cd)
HYBRID DIFFUSED	SM	20541	3.8	12	0.48	1	1000	9	29	60	885
	FM	20641	3.8	12	0.84	1	1000	9	29	60	885

A = LUX AT 10 METERS

B = BEAM DISTANCE (m) WITH 1 LUX

C = BEAM DISTANCE (m) WITH .25 LUX

KIT INCLUDES

- 2 Ignite Lights (Surface or Flush Mount)
- 2 Sets of Hardware
- 48" Wire Leads
- 2 Mounting Brackets (Surface

UV BLACK LIGHT KITS

The UV Black Light Kits were designed exclusively with the night fisherman in mind. The UV Black Light Kits will illuminate fluorescent fishing line, making it easy to detect subtle bites. The added SR-M Specter Driving Light Kit helps with making precise casts down the bank or to aide in netting a catch. Both lights include a 15' cord with a cigarette lighter adapter as well as a triple suction cup mount, making it easy to aim the light exactly where you want it anywhere on the boat. Whether you're a professional angler or you just enjoy night fishing, the Rigid Industries UV Black Light Kits will help increase the success of any night fisherman.



SINGLE LIGHT KIT



PART# 40108

KIT INCLUDES

- SR-M Specter Diffused UV Light
- Triple Suction Cup Mount
- 15ft. DC Cigarette Lighter Adapter with switch

COMBO LIGHT KIT



PART# 40107

KIT INCLUDES

- SR-M Specter Diffused UV Light
- SR-M Specter Driving Light
- Green Light Cover
- Triple Suction Cup Mount
- 15ft. DC Cigarette Lighter Adapter with switch

TROLLING MOTOR MOUNT LIGHT KIT

Available for several popular models of the Minn Kota® Fortrex® trolling motor, this mounting kit replaces the original diversion plate mounted on the nose of the trolling motor mount. The housing is constructed of PA66 glass filled nylon and shock-absorbing silicone rubber, while a 25' plug-and-play harness makes installation easy. This lighting kit makes it simple to see what's dead ahead without overpowering normal night vision. The kit even includes an amber lens cover for use in fog or rain.



TMM LIGHT KIT



PART# 40003

KIT INCLUDES

- Minn Kota® Fortrex® Trolling Motor Mount
- 25 ft. Plug and Play Harness with Waterproof Switch
- SR-M Specter Driving LED Light
- Amber Lens Cover

- Compatible with Minn Kota® Fortrex® 80, 101, 101H, and 112
- DISCLAIMER: Not compatible with boat models where factory navigation lights are installed in the forward most portion of the rub rail at the bow of the boat.

ROCK LIGHT KITS

The Rigid Industries Rock Light Kit uses the power and durability of A-Series LED lighting and adds custom 15' leads on each light, a distribution block, plus switch and angled mounts to light up any truck, Jeep, or all-terrain vehicle. This kit will allow you to light up the trail with strategically placed lights on the vehicle. Perfect for night rock-crawling, the LED lights are available in a variety of colors, including white, red, blue, green, or amber to aid night vision or accent vehicle colors. Rock Light Kits are available in 4-light or 6-light configurations to enhance and customize your night crawling experience.

4 LIGHT KIT

LIGHT COLOR	KIT PART NO.
White	40020
Red	40021
Green	40022
Blue	40023
Amber	40024
White	40025
Red	40026
Green	40027
Blue	40028
Amber	40029

6 LIGHT KIT

KIT INCLUDES

- A-Series with 15' Leads
- Distribution Block for Easy Wiring
- 8' Wiring Harness
- Angled Mounting Pads w/30o Angle
- Mounting Hardware



BACK-UP LIGHT KITS

Most factory back-up lights are inadequate for being able to clearly see what is behind the vehicle while in reverse. Fortunately, Rigid offers an easy solution with two different styles of Back-Up Light Kits. Available with either Rigid's SR-Q or SR-M LED lights with your choice of flush or surface mounting, the Back-Up Light Kits have a three-position switch that allows the user to toggle between on, off, or auto with reverse via a 25' wiring harness. Back-Up Light Kits illuminate the rear of the vehicle effectively, offering a simple and safe solution to a common problem among all vehicles.



FEATURE

- 3 POSITION SWITCH OPTIONS: on, off and auto with reverse

SR-Q KIT

MOUNT	KIT PART NO.
SM	98002
FM	98003
SM	98000
FM	98001

SR-M KIT

KIT INCLUDES

- (2) SR-Q Surface or Flush Mount Hybrid Diffusion Lights
- OR
- (2) SR-M Surface or Flush Mount Hybrid Diffusion Lights
- 25' Wiring Harness with Switch
- Mounting Hardware
- Black Covers for Pair of Lights (SM ONLY)

(SM) = Surface Mount
(FM) = Flush Mount



GRILLES & OE MOUNTS

pg 113 - pg 128

BUILD INCLUDES

Toyota Tacoma Grille | PG. 124
Toyota Tacoma SAE Kit | PG. 125
Toyota Tacoma Bumper Mount | PG. 125





VEHICLE SPECIFIC

ARCTIC CAT®

ARCTIC CAT GRILLE MOUNT



MODEL Wildcat®
YEAR 2012-2016
PART NO. 46521
FITS (1) 10" SR-Series
NOTE Light Sold Separately

ATV

ATV HANDLEBAR MOUNT

ATV
 N/A
 40230
 (2) D-Series
 Lights Sold Separately

MODEL
YEAR
PART NO.
FITS
NOTE



MODEL ATV
YEAR N/A
PART NO. 40630
FITS (1) 6" E or (1) 6" SR-Series
NOTE Light Sold Separately

ATV
 N/A
 41030
 (1) 10" E or (1) 10" SR-Series
 Lights Sold Separately

MODEL
YEAR
PART NO.
FITS
NOTE



CAN AM®

MAVERICK X DS HOOD MOUNT

Maverick X
 2014-2016
 46549
 (1) 10" SR-Series
 Light Sold Separately

MODEL
YEAR
PART NO.
FITS
NOTE



MAVERICK X DS ROOF MOUNT

Maverick X
 2014-2016
 46548
 (1) 40" RDS-Series
 Light Sold Separately

MODEL
YEAR
PART NO.
FITS
NOTE



MAVERICK X DS ROCK KIT

Maverick X
 2014-2016
 46551
 (4) A-Series
 Light Sold Separately

MODEL
YEAR
PART NO.
FITS
NOTE



MAVERICK X DS REVERSE MOUNT

Maverick X (Turbo Only)
 2014-2016
 46550
 (2) D-Series® (2) SR-M® or (1) SR-Q® Series
 Light Sold Separately

MODEL
YEAR
PART NO.
FITS
NOTE



VEHICLE SPECIFIC

CHEVY®

**WANT TO SEE
INSTALLED
GRILLES? VISIT
OUR WEBSITE &
SEARCH BY
PART NO.**



CHEVY RDS-SERIES LED GRILLE KITS

MODEL Silverado® 2500/3500
YEAR 2015-2017
PART NO. 41586
FITS (1) 30" RDS-Series
NOTE INCLUDES LIGHT



CHEVY LED GRILLES

MODEL Silverado 1500 Z71
YEAR 2014-2015
PART NO. 40576
FITS (2) 6" & (1) 10" SR-Series
NOTE Lights Sold Separately



MODEL Silverado 2500/3500
YEAR 2011-2014
PART NO. 40564
FITS (2) D-Series & (1) 10" SR-Series
NOTE Lights Sold Separately



MODEL Silverado 1500
YEAR 2007.5-2013
PART NO. 40565
FITS (2) SR-M Series & (1) 6" SR-Series
NOTE Lights Sold Separately

1500 & 2500/3500
2014-2015
40165
(1) 50" E-Series
Light Sold Separately

MODEL
YEAR
PART NO.
FITS
NOTE



CHEVY ROOF MOUNTS

MODEL 1500
YEAR 2014
PART NO. 40166
FITS (1) 54" RDS-Series
NOTE Light Sold Separately

1500
2007.5-2013
40167
(1) 50" E-Series
Light Sold Separately

MODEL
YEAR
PART NO.
FITS
NOTE



MODEL 1500
YEAR 2007.5-2013
PART NO. 40168
FITS (1) 50" E-Series
NOTE Light Sold Separately

1500
2014-2015
46517
(4) SR-M or (2) SR-Q Series
Lights Sold Separately

MODEL
YEAR
PART NO.
FITS
NOTE



CHEVY FOG LIGHT MOUNTS

MODEL 1500 2500/3500
YEAR 2007-2013 2007-2010
PART NO. 40337
FITS (4) D-Series
NOTE Lights Sold Separately

2500/3500
2015-2017
46535
(1) DXL or (2) D-Series
Lights Sold Separately

MODEL
YEAR
PART NO.
FITS
NOTE



MODEL 2500/3500
YEAR 2011-2014
PART NO. 40338
FITS (4) D-Series
NOTE Lights Sold Separately

Colorado
2015-2017
46579
(2) D-Series
Lights Sold Separately

MODEL
YEAR
PART NO.
FITS
NOTE



MODEL Colorado
YEAR 2015-2017
PART NO. 46583
FITS (2) D-Series
NOTE D-Series SAE Set Included

Tahoe / Suburban / Avalanche
2007-2013
46577
(2) D-Series
Lights Sold Separately

MODEL
YEAR
PART NO.
FITS
NOTE



MODEL Tahoe / Suburban / Avalanche
YEAR 2007-2013
PART NO. 46582
FITS (2) D-Series
NOTE D-Series SAE Set Included

VEHICLE SPECIFIC

CHEVY

CHEVY BUMPER MOUNTS

Colorado
2015-2017
46573
(1) 30" SR-Series
Lights Sold Separately

MODEL
YEAR
PART NO.
FITS
NOTE



MODEL
YEAR
PART NO.
FITS
NOTE

2500/3500
2015-2017
46536
(2) 6" E or (2) SR-Series
Lights Sold Separately

2500/3500
2011-2014
40339
(1) 20" E or (1) SR-Series
Lights Sold Separately

MODEL
YEAR
PART NO.
FITS
NOTE



MODEL
YEAR
PART NO.
FITS
NOTE

1500 & 2500/3500
2007.5-2013 2007-2010
40336
(1) 20" SR-Series
Light Sold Separately

DODGE

DODGE RDS-SERIES GRILLE KITS

RAM[®] 1500
2015-2017
41585
(1) 30" RDS-Series
INCLUDES LIGHT

MODEL
YEAR
PART NO.
FITS
NOTE



RAM 1500
2009-2012
41593
(1) 30" RDS-Series
INCLUDES LIGHT

MODEL
YEAR
PART NO.
FITS
NOTE



RAM 2500-3500
2013-2017
41588
(1) 30" RDS-Series
INCLUDES LIGHT

MODEL
YEAR
PART NO.
FITS
NOTE



RAM 2500-3500
2010-2012
41578
(1) 20" RDS-Series
INCLUDES LIGHT

MODEL
YEAR
PART NO.
FITS
NOTE



**RDS LIGHT BARS
INCLUDED WITH
RDS GRILLES**

DODGE BUMPER MOUNTS



MODEL
YEAR
PART NO.
FITS
NOTE

RAM 2500/3500
2004-2017
40240
(1) 20" SR-Series
Light Sold Separately

DODGE ROOF MOUNTS

RAM 1500 & 2500/3500
2010-2015
40169
(1) 50" E-Series
Light Sold Separately

MODEL
YEAR
PART NO.
FITS
NOTE



MODEL
YEAR
PART NO.
FITS
NOTE

RAM 1500 & 2500/3500
2010-2015
40170
(1) 54" RDS-Series
Light Sold Separately

DODGE FOG LIGHT MOUNTS

RAM 1500 & 2500/3500
2009-2012 2010-2017
46510
(4) D-Series
Lights Sold Separately

MODEL
YEAR
PART NO.
FITS
NOTE



MODEL
YEAR
PART NO.
FITS
NOTE

RAM 1500 & 2500/3500
2002-2008 2003-2009
46541
(2) D-Series
Lights Sold Separately

VEHICLE SPECIFIC

FORD®

**SECURITY
HARDWARE
INCLUDED WITH
THIS GRILLE**



FORD RDS-SERIES GRILLE KITS

MODEL Raptor® SVT™ (Without Camera)
YEAR 2009-2015
PART NO. 41572
FITS (1) 30" RDS-Series
NOTE INCLUDES LIGHT



MODEL Raptor SVT (With Camera)
YEAR 2009-2015
PART NO. 41571
FITS (1) 30" RDS-Series
NOTE INCLUDES LIGHT



MODEL Super Duty™
YEAR 2011-2016
PART NO. 41580
FITS (1) 30" RDS-Series
NOTE INCLUDES LIGHT



MODEL F-150
YEAR 2015-2017
PART NO. 41550
FITS (1) 30" RDS-Series
NOTE INCLUDES LIGHT & SECURITY HARDWARE



MODEL F-150®
YEAR 2013-2014
PART NO. 41582
FITS (1) 30" RDS-Series
NOTE INCLUDES LIGHT

Raptor & F-150
 2009-2015 2004-2014
 40161
 (1) 54" RDS-Series
 Light Sold Separately

MODEL
YEAR
PART NO.
FITS
NOTE



FORD ROOF MOUNTS

MODEL Raptor & F-150
YEAR 2009-2015 2004-2014
PART NO. 40160
FITS (1) 50" E-Series
NOTE Light Sold Separately

Super Duty
 1999-2015
 40162
 (1) 50" E-Series
 Light Sold Separately

MODEL
YEAR
PART NO.
FITS
NOTE



MODEL Super Duty
YEAR 1999-2015
PART NO. 40163
FITS (1) 54" RDS-Series
NOTE Light Sold Separately



MODEL Raptor SVT
YEAR 2009-2015
PART NO. 40237
FITS (1) 50" E-Series
NOTE Light Sold Separately

VEHICLE SPECIFIC

FORD

FORD GRILLE KITS

F-150
2009-2012
40558
PART NO.
(2) 6" & (1) 10" SR-Series
FITS
Lights Sold Separately
NOTE



F-150
2004-2008
40587
PART NO.
(1) 20" E-Series
FITS
Light Sold Separately
NOTE

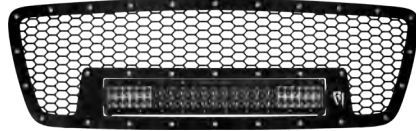

Super Duty
2011-2016
40566
PART NO.
(1) 30" E-Series
FITS
Light Sold Separately
NOTE



Super Duty
2008-2010
40567-FX4 or 40577-Non FX4
PART NO.
(2) D-Series & (1) 20" E-Series
FITS
Lights Sold Separately
NOTE



RI STAR GRILLE
EMBLEM
INCLUDED WITH
ALL GRILLES

FORD BUMPER MOUNTS

Raptor
2009-2015
40133
PART NO.
(1) 20" E-Series
FITS
Light Sold Separately
NOTE



MODEL Raptor
YEAR 2009-2015
PART NO. 40134
FITS (2) 4" E-Series
NOTE Light Sold Separately

F-150
2009-2014
46529
PART NO.
(1) 20" E-Series
FITS
Light Sold Separately
NOTE



MODEL Raptor
YEAR 2009-2015
PART NO. 40236
FITS (1) 40" E-Series
NOTE Light Sold Separately

F-150
2006-2008
46519
PART NO.
(1) 20" E or SR, or (2) 20" SR-Series
FITS
Lights Sold Separately
NOTE



MODEL Super Duty
YEAR 2011-2015
PART NO. 40136
FITS (1) 20" E or SR-Series
NOTE Lights Sold Separately

Super Duty
2011-2016
46545
PART NO.
(1) 40" RDS or (1) 40" E-Series
FITS
Lights Sold Separately
NOTE



MODEL Super Duty
YEAR 2008-2010
PART NO. 46545
FITS (1) 20" E-Series/Radiance,
(1) 20" RDS-Series, (1) 20" SR-Series,
or (2) 20" SR-Series
NOTE Lights Sold Separately

FORD FOG LIGHT MOUNTS

Raptor
2009-2015
40235
PART NO.
(4) D-Series
FITS
Lights Sold Separately
NOTE



F-150
2015-2017
46555
PART NO.
(4) D-Series
FITS
Lights Sold Separately
NOTE



MODEL F-150
YEAR 2006-2014
PART NO. 46527
FITS (2) D-Series
NOTE Lights Sold Separately

Super Duty
1999-2016
46503
PART NO.
(2) D-Series
FITS
Lights Sold Separately
NOTE



MODEL Super Duty
YEAR 2011-2016
PART NO. 46504
FITS (2) Q-Series
NOTE Lights Sold Separately

VEHICLE SPECIFIC

GMC®

GMC RDS-SERIES GRILLE KITS



MODEL 1500
YEAR 2016-2017
PART NO. 41599
FITS (1) 30" RDS-Series
NOTE INCLUDES LIGHT



MODEL 1500
YEAR 2011-2013
PART NO. 41589
FITS (1) 20" RDS-Series
NOTE INCLUDES LIGHT



MODEL 2500/3500
YEAR 2015-2017
PART NO. 41584
FITS (1) 30" RDS-Series
NOTE INCLUDES LIGHT



MODEL 2500/3500
YEAR 2011-2014
PART NO. 41590
FITS (1) 20" RDS-Series
NOTE INCLUDES LIGHT



MODEL Yukon®
YEAR 2015-2017
PART NO. 41592
FITS (1) 30" RDS-Series
NOTE INCLUDES LIGHT

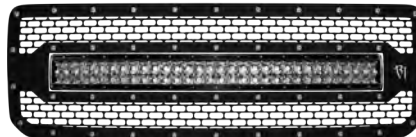

MODEL Canyon®
YEAR 2015-2017
PART NO. 41595
FITS (1) 30" RDS-Series
NOTE INCLUDES LIGHT

LASER CUT 304
 STAINLESS STEEL
 CONSTRUCTION

GMC GRILLE KITS



MODEL 1500
YEAR 2014-2015
PART NO. 40573
FITS (2) D-Series & (1) 20" E-Series
NOTE Lights Sold Separately



MODEL 1500
YEAR 2011-2013
PART NO. 40568
FITS (2) D-Series & (1) 10" E-Series
NOTE Lights Sold Separately



MODEL 2500/3500
YEAR 2011-2014
PART NO. 40569
FITS (2) D-Series & (1) 10" E-Series
NOTE Lights Sold Separately

VEHICLE SPECIFIC

GMC

GMC ROOF MOUNTS

1500
2014
40166
PART NO.
(1) 54" RDS-Series
Light Sold Separately
FITS
NOTE



MODEL 1500
YEAR 2007.5-2013
PART NO. 40167
FITS (1) 50" E-Series
NOTE Light Sold Separately

1500
2007.5-2013
40168
PART NO.
(1) 50" RDS-Series
Light Sold Separately
FITS
NOTE



MODEL 1500 & 2500/3500
YEAR 2014-2015
PART NO. 40165
FITS (1) 50" E-Series
NOTE Light Sold Separately

GMC BUMPER MOUNTS

1500 & 2500/3500
2011-2013 2007-2010
46505
PART NO.
(1) 20" SR-Series
Light Sold Separately
FITS
NOTE



MODEL 2500/3500
YEAR 2011-2014
PART NO. 46506
FITS (1) 20" E or SR-Series or (2) 20" SR-Series
NOTE Lights Sold Separately

GMC FOG LIGHT BRACKETS

1500
2014-2015
46511
PART NO.
(2) D-Series
Lights Sold Separately
FITS
NOTE



MODEL 1500 & 2500/3500
YEAR 2008-2013 2008-2010
PART NO. 46507
FITS (2) D-Series
NOTE Lights Sold Separately

1500 & 2500/3500
2007-2013 2007-2010
40338
PART NO.
(2) D-Series
Lights Sold Separately
FITS
NOTE



MODEL 2500/3500
YEAR 2015-2017
PART NO. 46543
FITS (2) D-Series
NOTE Lights Sold Separately

2500/3500
2011-2014
46508
PART NO.
(2) D-Series
Lights Sold Separately
FITS
NOTE



HONDA®

HONDA HEADLIGHT MOUNT

CRF®
2004-2016
46516
PART NO.
(1) SR-Q Series
Light Sold Separately
FITS
NOTE



HYUNDAI®

HYUNDAI MOUNT

Tucson®
2016-2017
46557
PART NO.
(2) 6" E or SR-Series
Light Sold Separately
FITS
NOTE



VEHICLE SPECIFIC

JEEP®

JEEP GRILLE KITS

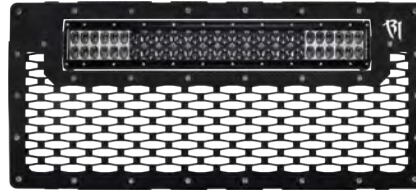

MODEL Wrangler® JK
YEAR 2007-2017
PART NO. 40591
FITS (1) 20" E-Series
NOTE Light Sold Separately

JEEP HOOD MOUNTS

Wrangler JK
 2007-2015
 40332
 (1) 10" E or (1) 10" SR-Series
 Light Sold Separately

MODEL
YEAR
PART NO.
FITS
NOTE



MODEL Wrangler JK
YEAR 2007-2017
PART NO. 40333
FITS (1) 20" E or (1) 20" SR-Series
NOTE Light Sold Separately

JEEP WINDSHIELD MOUNTS

Wrangler JK
 2007-2017
 40131
 (1) 50" E or (1) 50" SR-Series
 Lights Sold Separately

MODEL
YEAR
PART NO.
FITS
NOTE



MODEL Wrangler TJ
YEAR 1997-2006
PART NO. 40137
FITS (1) 50" E or (1) 50" SR-Series
NOTE Lights Sold Separately

JEEP A-PILLAR MOUNTS

Wrangler JK
 2007-2017
 (single) 40331
 (2) D-Series
 Lights Sold Separately

MODEL
YEAR
PART NO.
FITS
NOTE



MODEL Wrangler JK
YEAR 2007-2017
PART NO. 40139 (single swivel)
FITS (2) D-Series
NOTE Lights Sold Separately

Wrangler JK
 2007-2017
 (pair) 40335
 (4) D-Series
 Lights Sold Separately

MODEL
YEAR
PART NO.
FITS
NOTE



MODEL Wrangler
YEAR 2007-2017
PART NO. 46502
FITS (2) Q-Series
NOTE Lights Sold Separately

JEEP TAIL LIGHT MOUNTS

Wrangler JK
 2007-2017
 (Driver Side) 40311
 (1) SR-M or (1) SR-Q Series
 Lights Sold Separately

MODEL
YEAR
PART NO.
FITS
NOTE



MODEL Wrangler JK
YEAR 2007-2017
PART NO. 40322 (Passenger Side)
FITS (1) SR-M or (1) SR-Q Series
NOTE Lights Sold Separately

JEEP FOG LIGHT MOUNT

Wrangler JK
 2007-2017
 40138
 (2) D-Series
 Lights Sold Separately

MODEL
YEAR
PART NO.
FITS
NOTE



MODEL Wrangler JK
YEAR 2007-2017
PART NO. 40138
FITS (2) D-Series
NOTE Lights Sold Separately

VEHICLE SPECIFIC

KAWASAKI®

KAWASAKI GRILLE MOUNT

Teryx®
2010-2015
46515
(1) 10" SR-Series
Light Sold Separately

MODEL
YEAR
PART NO.
FITS
NOTE



KTM®

KTM HEADLIGHT MOUNTS

KTM
2013.5-2016
(Top or Bottom) 46514
TOP (2)SRM BOTTOM (1)SRQ or (2)SRQ
Lights Sold Separately

MODEL
YEAR
PART NO.
FITS
NOTE



MODEL
YEAR
PART NO.
FITS
NOTE

KTM
2007-2013
46513
TOP(1) SR-Q Series BOTTOM (1) SR-M
Lights Sold Separately

NISSAN®

NISSAN GRILLE KITS

Titan® (Without Camera)
2016-2017
40549
20" E-Series or Radiance
Light Sold Separately

MODEL
YEAR
PART NO.
FITS
NOTE

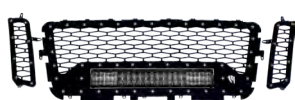

MODEL
YEAR
PART NO.
FITS
NOTE

Frontier
2009-2016
40598
(1) 10" E-Series
Light Sold Separately

Titan®(With Camera)
2016-2017
40548
20" E-Series or Radiance
Light Sold Separately

MODEL
YEAR
PART NO.
FITS
NOTE



MODEL
YEAR
PART NO.
FITS
NOTE

Titan® & Armada®
2004-2015 2004-2007
40583
(1) 20" E-Series
Light Sold Separately

NISSAN FOG MOUNT

Titan
2016-2017
46580
(2) D-Series
Light Sold Separately

MODEL
YEAR
PART NO.
FITS
NOTE



MODEL
YEAR
PART NO.
FITS
NOTE

Titan
2016-2017
46585
(2) D-Series
Light Sold Separately

Titan
2004-2015
46561
(2) D-Series
Light Sold Separately

MODEL
YEAR
PART NO.
FITS
NOTE



Frontier
2009-2016 46578
(2) D-Series
Light Sold Separately

MODEL
YEAR
PART NO.
FITS
NOTE

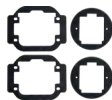

MODEL
YEAR
PART NO.
FITS
NOTE

Frontier
2009-2016
46584
(2) D-Series
D-Series SAE Set Included

NISSAN BUMPER MOUNT

Titan
2016-2017
46581
(1) 20" E or SR or Radiance
Light Sold Separately

MODEL
YEAR
PART NO.
FITS
NOTE



VEHICLE SPECIFIC

POLARIS®

RZR® XP1000
2014-2016
40574
(1) 10" SR-Series
Light Sold Separately

MODEL
YEAR
PART NO.
FITS
NOTE



POLARIS GRILLE KITS

MODEL RZR XP1000
YEAR 2012-2013
PART NO. 40557
FITS (1) 10" SR-Series
NOTE Light Sold Separately

Ranger®
2012-2013
40340
(1) 10" SR-Series
Light Sold Separately

MODEL
YEAR
PART NO.
FITS
NOTE



MODEL Sportsman 850
YEAR 2009-2014
PART NO. 46553
FITS (1) 6" SR-Series
NOTE Light Sold Separately

RZR 170 GRILLE & A-PILLARS



MODEL RZR 170
YEAR 2009-2017
PART NO. 46546
FITS fits (2) SR-M's or (2) Rigid Ignite™
NOTE Light Sold Separately

RZR XP1000
2014-2016
46526
(2)PAR46 or (2)DXL or (2)D-Series
Lights Sold Separately

MODEL
YEAR
PART NO.
FITS
NOTE



POLARIS A-PILLAR MOUNTS

MODEL RZR XP1000
YEAR 2014-2016
PART NO. 46528 (Double)
FITS (4) D-Series
NOTE Lights Sold Separately

POLARIS B-PILLAR MOUNTS



MODEL RZR XP1000 (2 Seater Only)
YEAR 2014-2016
PART NO. 46533
FITS (2)SR-M or (2)SR-Q or (2)D-Series
NOTE Lights Sold Separately

RZR XP1000
2014-2015
46532
(1) 30" E or (1) 30" SR-Series
Lights Sold Separately

MODEL
YEAR
PART NO.
FITS
NOTE



POLARIS ROOF MOUNTS

MODEL RZR XP1000
YEAR 2014-2015
PART NO. 46531
FITS (1) 30" RDS-Series
NOTE Light Sold Separately

POLARIS DOME LIGHT KIT



MODEL RZR XP1000
YEAR 2014-2016
PART NO. 46522
FITS (2) A-Series
NOTE Kit Sold Separately

VEHICLE SPECIFIC

POLARIS

POLARIS FENDER KIT

RZR XP900 / XP1000
2014-2016
46562
(2) SR-M
(2) SR-M Flush Mounts Included

MODEL
YEAR
PART NO.
FITS
NOTE



POLARIS REVERSE LIGHT KIT

RZR XP1000
2014-2016
46534
(2) SR-M or (2) SR-Q Series
Kit Sold Separately

MODEL
YEAR
PART NO.
FITS
NOTE



POLARIS LIGHT MOUNT KITS

RZR XP1000
2014-2016
46539
Rock Light Kit
Lights Sold Separately

MODEL
YEAR
PART NO.
FITS
NOTE



MODEL
YEAR
PART NO.
FITS
NOTE

RZR XP1000
2014-2016
46554
(4) D-Series
Lights Sold Separately

RZR XP1000
2014-2016
46560
(4) D-Series
INCLUDES LIGHTS

MODEL
YEAR
PART NO.
FITS
NOTE



Sportsman 850
2009-2014
46552
(2) D-Series or (1) 6" E-Series
Kit Sold Separately

MODEL
YEAR
PART NO.
FITS
NOTE



SUBARU®

WRX/STI Bumper Mount Kit.

WRX/STI
2010-2014
46524
(2) 6" E-Series
(2) 6" SAE Compliant
E-Series Included

MODEL
YEAR
PART NO.
FITS
NOTE



**BUMPER
MOUNT KIT
INCLUDES
LIGHTS**

VEHICLE SPECIFIC

TOYOTA®

TOYOTA GRILLE KITS

FJ Cruiser®
2005-2014
(2 Piece) 40551
(2) D-Series & (2) 6" SR-Series
Lights Sold Separately

MODEL
YEAR
PART NO.
FITS
NOTE

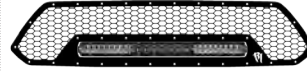
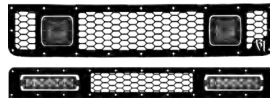

MODEL
YEAR
PART NO.
FITS
NOTE

Tacoma®
2012-2015
40552
(1) 20" SR-Series
Light Sold Separately

FJ Cruiser
2005-2014
(Upper Piece) 40560
(2) D-Series
Lights Sold Separately

MODEL
YEAR
PART NO.
FITS
NOTE

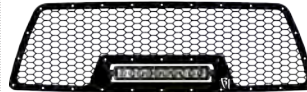
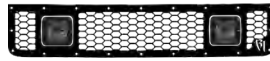

MODEL
YEAR
PART NO.
FITS
NOTE

Tacoma
2005-2011
40553
(1) 10" SR-Series
Light Sold Separately

FJ Cruiser
2005-2014
(Lower Piece) 40561
(2) 6" SR-Series
Lights Sold Separately

MODEL
YEAR
PART NO.
FITS
NOTE

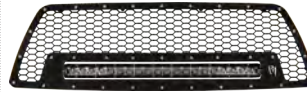
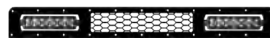

MODEL
YEAR
PART NO.
FITS
NOTE

Tacoma
2005-2011
40575
(1) 20" SR-Series
Light Sold Separately

4Runner®
2014-2016
40596
(1) 20" E-Series
Light Sold Separately

MODEL
YEAR
PART NO.
FITS
NOTE



MODEL
YEAR
PART NO.
FITS
NOTE

Tundra®
2014-2017
40570
(2) D-Series & (1) 20" E-Series
Lights Sold Separately

4Runner
2010-2013
(2 Piece) 40556
(1) 20" SR-Series & (2) D-Series
Lights Sold Separately

MODEL
YEAR
PART NO.
FITS
NOTE

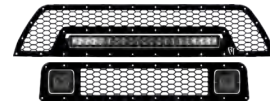

MODEL
YEAR
PART NO.
FITS
NOTE

Tundra
2010-2013
40554
(1) 30" SR-Series
Light Sold Separately

4Runner
2010-2013
(Upper Piece) 40562
(1) 20" SR-Series
Light Sold Separately

MODEL
YEAR
PART NO.
FITS
NOTE



MODEL
YEAR
PART NO.
FITS
NOTE

Tundra
2010-2013
40555
(2) 6" SR-Series & (1) 10" SR-Series
Lights Sold Separately

4Runner
2010-2013
(Lower Piece) 40563
(2) D-Series
Lights Sold Separately

MODEL
YEAR
PART NO.
FITS
NOTE

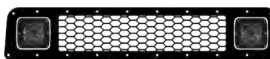

LASER CUT 304 STAINLESS STEEL CONSTRUCTION

Hilux®
2012-2015
40594
(1) 20" SR-Series
Light Sold Separately

MODEL
YEAR
PART NO.
FITS
NOTE



Tacoma®
2016-2017
40597
(1) 20" E-Series or Radiance
Light Sold Separately

MODEL
YEAR
PART NO.
FITS
NOTE



VEHICLE SPECIFIC

TOYOTA

TOYOTA ROOF MOUNTS

Tundra
2014-2015
40164
(1) 54" RDS-Series
Light Sold Separately

MODEL
YEAR
PART NO.
FITS
NOTE



TOYOTA BUMPER MOUNTS

Hilux
2012-2015
46538
(1) 20" E or (1) 20" SR-Series
Light Sold Separately

MODEL
YEAR
PART NO.
FITS
NOTE



MODEL
YEAR
PART NO.
FITS
NOTE

Tundra
2014-2017
46512
(1) 30" SR-Series
Light Sold Separately

Tacoma
2016-2017
46565
(1) 30" SR-Series
Light Sold Separately

MODEL
YEAR
PART NO.
FITS
NOTE



MODEL
YEAR
PART NO.
FITS
NOTE

Tacoma
2016-2017
46568
(1) 30" SR-Series
(1) 30" SR-Series Included

Tacoma
2005-2015
40156
(1) 30" SR-Series
Light Sold Separately

MODEL
YEAR
PART NO.
FITS
NOTE



TOYOTA FOG LIGHT MOUNTS

Tacoma
2016-2017
46566
(2) D-Series
Lights Sold Separately

MODEL
YEAR
PART NO.
FITS
NOTE



MODEL
YEAR
PART NO.
FITS
NOTE

Tacoma
2016-2017
46567
(2) D-Series
(2) SAE D-Series Included

Tacoma
2012-2015
46509
(2) SR-M Series
Lights Sold Separately

MODEL
YEAR
PART NO.
FITS
NOTE



MODEL
YEAR
PART NO.
FITS
NOTE

Tacoma & Tundra
2005-2011 2007-2013
46530
(2) D-Series
Lights Sold Separately

Tundra
2014-2017
46520
(2) D-Series
Lights Sold Separately

MODEL
YEAR
PART NO.
FITS
NOTE



MODEL
YEAR
PART NO.
FITS
NOTE

4Runner
2014-2016
46540
(2) D-Series
Lights Sold Separately

Hilux
2012-2015
46525
(2) D-Series
Lights Sold Separately

MODEL
YEAR
PART NO.
FITS
NOTE



TOYOTA ROOF RACK MOUNTS

FJ Cruiser
2005-2014
40132
(1) 20" E-Series & (2) 10" E-Series
Lights Sold Separately

MODEL
YEAR
PART NO.
FITS
NOTE



VEHICLE SPECIFIC

YAMAHA®

YXZ SHOCK MOUNT



MODEL YXZ1000R
YEAR 2016-2017
PART NO. 46576
FITS (1) 10" SR-Series
NOTE Light Sold Separately

YXZ A-PILLAR MOUNTS



MODEL YXZ1000R
YEAR 2016-2017
PART NO. 46569
FITS (2) D/DXL/SR-M/SR-Q/
PAR46/Rigid Ignite
NOTE Light Sold Separately

YXZ B-PILLAR MOUNTS



MODEL YXZ1000R
YEAR 2016-2017
PART NO. 46570
FITS (2) D/DXL/SR-M/SR-Q/
PAR46/Rigid Ignite
NOTE Light Sold Separately

YXZ ROOF MOUNTS



MODEL YXZ1000R
YEAR 2016-2017
PART NO. 46575
FITS (1) 38" E or SR-Series
NOTE Light Sold Separately

YXZ ROCK LIGHT MOUNTS



MODEL YXZ1000R
YEAR 2016-2017
PART NO. 46571
FITS (4) A-Series
NOTE Light Sold Separately

YXZ DOME LIGHT MOUNT



MODEL YXZ1000R
YEAR 2016-2017
PART NO. 46572
FITS (1) A-Series
NOTE Light Sold Separately

MADE IN THE
USA

SPECIALTY MOUNTS

FIRE TRUCK

BROW MOUNTS

(Black) 40001
Up to (2) SR-Series
Lights Sold Separately

PART NO.
FITS
NOTE



PART NO. 40002 (White)
FITS Up to (2) SR-Series
NOTE Lights Sold Separately

Rigid Industries Brow Mounts provide a straightforward high-output lighting solution to any fire apparatus. Engineered to fit up to two SR Series Light Bars or one E-Series Light Bar, the Brow Mount tabs utilize a through-bolt system for a simple and versatile installation.

POLE MOUNT

40095
Fits All Light Series And Cradles
Lights Sold Separately

PART NO.
FITS
NOTE



Pole Mounts provide a highly portable way to light up any scene. Utilizing the pole or tripod of choice, these brackets are engineered to fit two Q-Series Cubes or one 10" E-Series Light bar. The mount is easily adjustable, enabling compact, powerful lighting to be focused anywhere needed.

"THIS IS HOW I
LOOK WITH TWO
Q-SERIES."

- POLE MOUNT



SPECIALTY MOUNTS

RI ACCESSORIES BY RAM®

RAM stands for "Round A-Mount" and features a unique, patented ball and socket design that provides a full 180° rotation of your mounted light. The ball is made from an elastomeric rubber, gripping the socket while also providing shock and vibration dampening. These mounts are compatible with Rigid Industries SR-M, SR-Q and D-Series LED lights. With RAM Mounts, the only limitation for lighting options is your imagination.

40060 Bolt Down 6" 6.25 x 2 Lights Sold Separately	PART NO. MOUNT ARM PLATE NOTE			PART NO. MOUNT ARM PLATE NOTE	40061 Pole Mount (0.5" - 1.25") 3.7" 1 x 1 Light Sold Separately
40069 Bolt Down 3.7" 1 x 1 Light Sold Separately	PART NO. MOUNT ARM PLATE NOTE			PART NO. MOUNT ARM PLATE NOTE	40063 Suction Cup 3.7" 6.25 x 2 Lights Sold Separately
40071 Bolt Down 2.4" 1 x 1 Light Sold Separately	PART NO. MOUNT ARM PLATE NOTE			PART NO. MOUNT ARM PLATE NOTE	40064 Suction Cup 3.7" 1 x 1 Light Sold Separately
40073 Bolt Down 6" 1 x 1 Light Sold Separately	PART NO. MOUNT ARM PLATE NOTE			PART NO. MOUNT ARM PLATE NOTE	40065 Suction Cup 2.4" 6.25 x 2 Lights Sold Separately
40074 Bolt Down 2.4" 6.25 x 2 Lights Sold Separately	PART NO. MOUNT ARM PLATE NOTE			PART NO. MOUNT ARM PLATE NOTE	40066 Suction Cup 2.4" 1 x 1 Light Sold Separately
40075 Bolt Down 3.7" 6.25 x 2 Lights Sold Separately	PART NO. MOUNT ARM PLATE NOTE			PART NO. MOUNT ARM PLATE NOTE	40067 Suction Cup 6" 6.25 x 2 Lights Sold Separately
40062 (0.5" - 1.25") Pole Mount 2.4" 1 x 1 Light Sold Separately	PART NO. MOUNT ARM PLATE NOTE			PART NO. MOUNT ARM PLATE NOTE	40068 Suction Cup 6" 1 x 1 Light Sold Separately
40070 (3") Pole Mount 3.7" 1 x 1 Light Sold Separately	PART NO. MOUNT ARM PLATE NOTE			PART NO. MOUNT ARM PLATE NOTE	40094 Double Suction Cup n/a 6.25 x 2 Lights Sold Separately
40072 (3") Pole Mount 2.4" 1 x 1 Light Sold Separately	PART NO. MOUNT ARM PLATE NOTE				

ACCESSORIES

pg 131 - pg 135

BUILD INCLUDES

D-SS LIGHT COVER | PG. 132





MOUNTING OPTIONS

FLUSH MOUNT BUCKETS

Gasket provided for weather proofing. 15° vertical direction adjustments.

PART NO.	FITS
48301B	A-Series - Black
48301W	A-Series - White
40010B	4" E-Series - Black
40010W	4" E-Series - White
40011B	6" E-Series - Black
40011W	6" E-Series - White
40012B	10" E-Series - Black
40012W	10" E-Series - White
40013B	6" SR-Series - Black
40013W	6" SR-Series - White
40014B	10" SR-Series - Black
40014W	10" SR-Series - White
40015B	Q-Series - Black
40015W	Q-Series - White

ANGLED FLUSH MOUNT KIT

PART NO.	FITS	ANGLE DIRECTION
49000	D-Series	Down
49010	D-Series	Side
49002	SR-Q	Down
49013	SR-Q	Side
49001	SR-M	Down
49011	SR-M	Side

A-SERIES MOUNTING KITS

PART NO.	ANGLE DIRECTION
40007	Angled Mount
40008	Radius Mount

LIGHT BAR CLAMPS

Compatible with the E, SR & RDS-Series
Two Per Set
Hardware Included

SINGLE BAR CLAMP

Compatible with D, SR-Q & SR-M Series

SIZE	A-PILLAR	HORIZ	VERT
875"	40830	40840	40850
1.0"	41130	41040	41050
1.125"	41230	41240	41250
1.25"	42530	42540	42550
1.50"	45030	45040	45050
1.625"	46230	46240	46250
1.70"	47030	47040	47050
1.75"	47530	47540	47550
1.875"	48530	48540	48550
2"	42030	42040	42050
2.25"	42230	42240	42250
2.375"	42330	42340	42350
2.5"	45230	45240	45250
2.625"	42630	42640	42650
2.75"	42730	42740	42750
2.875"	42830	42840	42850
3"	43030	43040	43050
3.25"	43230	43240	43250

SIZE	E/SR	RDS
875"	40820	40821
1.0"	41020	41021
1.125"	41120	41121
1.25"	42520	42521
1.50"	45020	45021
1.625"	46220	46221
1.70"	47020	47021
1.75"	47520	47521
1.875"	48720	48721
2"	42020	42021
2.25"	42220	42221
2.375"	42320	42321
2.5"	45220	45221
2.625"	42620	42621
2.75"	42720	42721
2.875"	42820	42821
3"	43020	43021
3.25"	43220	43221

CRADLES

Compatible with E-Series & SR-Series
Hardware included

SIZE	E-SERIES (BLACK)	E-SERIES (WHITE)	SR-SERIES (BLACK)
4"	40410	40411	.
6"	40610	40611	40690
10"	41010	41011	41090
20"	42010	.	42090
30"	43010	.	43090
40"	44010	.	44090



41010
10" E-Series

LICENSE PLATE BRACKET

Mountable with compact LED lights



PART NO.
40016

EXTENDED D-SERIES BRACKET

PART NO.
46537



WELD ON TABS

Compatible with E-Series & SR-Series



PART NO.
40291 Flat (Pair)
40292 Radius (Pair)

LIGHT COVERS

SINGLE LIGHT COVERS

COLOR	E / RDS / RADIANCE 10"	RDS 11"	E 4"	E 6"	SR 6"	SR 10"
Black	10574	10552	10491	10691	10584	19091
Clear	10575	10553	10492	10692	10588	19092
Amber	10576	10554	10493	10693	10586	19093
Blue	10577	10555	10494	10694	10587	19094
Red	10578	10556	10495	10695	10590	19095
White	10579	10557	10496	10696	10585	19096
Green	10580	10558	10497	10697	10589	19097
Smoke	10581	10559	10498	10698	10591	19098

COLOR	DXL	D	D-SS	SR-Q	SR-M	Q	R 46
Black	32191	20191	32181	31191	30191	10391	63391
Clear	32192	20192	32182	31192	30192	10392	63392
Amber	32193	20193	32183	31193	30193	10393	63393
Blue	32194	20194	32184	31194	30194	10394	63394
Red	32195	20195	32185	31195	30195	10395	63395
White	32196	20196	32186	31196	30196	10396	63396
Green	32197	20197	32187	31197	30197	10397	63397
Smoke	32198	20198	32188	31198	30198	10398	63398

BLACK & WHITE ARE OPAQUE. CLEAR, AMBER, BLUE, RED, WHITE, GREEN & SMOKE ARE TRANSLUCENT

LIGHT COVER KITS

LIGHT SIZE	COLOR	PART NO.	INCLUDED
20" SR-Series	Black	19291	(2) 10" Covers
30" SR-Series	Black	19391	(3) 10" Covers
40" SR-Series	Black	19491	(4) 10" Covers
50" SR-Series	Black	19591	(5) 10" Covers
20" E-Series	Black	12091	(2) 10" Covers
30" E-Series	Black	13091	(3) 10" Covers
40" E-Series	Black	14091	(4) 10" Covers
50" E-Series	Black	15091	(5) 10" Covers
20" RDS-Series	Black	10570	(2) 10" Covers
30" RDS-Series	Black	10571	(3) 10" Covers
40" RDS-Series	Black	10572	(4) 10" Covers
50" RDS-Series	Black	10573	(5) 10" Covers
54" RDS-Series	Black	10561	(5) 11" Covers
54" RDS-Series	Clear	10562	(5) 11" Covers
54" RDS-Series	Amber	10563	(5) 11" Covers
54" RDS-Series	Blue	10564	(5) 11" Covers
54" RDS-Series	Red	10565	(5) 11" Covers
54" RDS-Series	White	10566	(5) 11" Covers
54" RDS-Series	Green	10567	(5) 11" Covers
54" RDS-Series	Smoke	10568	(5) 11" Covers



Q-SERIES DIFFUSION KIT

PART NO.	INCLUDED
40034	Clear Cover + 4 Diff Lenses
40036	Amber Cover + 4 Diff Lenses
40037	Green Cover + 4 Diff Lenses



Diffusion Lens Q-Series



Green Q-Series

WIRING

WIRING HARNESS

PART NO.	FITS
40199	SR-M or SR-Q
40195	D-Series - Hybrid (Pair)
40196	D-Series - Specter (Pair)
40192	Back Up Light Kit Harness D-Series, Dually XL, SR-Q or SR-M
40194	D-Series (Single), 4" E-Series, or 6" SR-Series
40193	10"- 50" SR-Series or 10"- 30" E-Series
40190	Hi Power 40"- 50" E-Series or 20"- 30" RDS-Series
40200	Radiance Light Bars 10"- 50"
40300	Radiance Pads



40196

40188
H/L = High / Low



3 WIRE HARNESS

PART NO.	FITS
40187	Hybrid Optic - High Power Single Light 20"- 50" Amber & White Dual Function E-Series
40188	Specter Optic - Low Power Single Light D-Series H/L (Single), 4"- 10" E-Series H/L, 6" & 10" SR-Series H/L or SR-Q Series H/L
40189	Specter Optic - Low Power Pair D-Series H/L (Pair) or SR-Q Series H/L (Pair)

IN-LINE SWITCH

PART NO.	LENGTH
40051	24"



12V CIGARETTE LIGHTER ADAPTER

Length: 15'

PART NO.	FITS
40009	D-Series (Pair), SR-M (Pair), SR-Q (Pair)



PENDANT SWITCH KIT

Length: 15'

PART NO.	LENGTH
40052	24"



HARNESS EXTENSION

Length: 1 Meter

PART NO.	FITS
40197	30" or smaller lights
40198	40" or larger lights



40197

ROCKER SWITCHES

Replacement for 12V and 24V DC systems

PART NO.	FITS
40191	2 Position Replacement Switch
40181	3 Position May be used with Dual Function LED Lights & Back Up Light Kits



40191

LED FLASHER

Works with up to 10 inch light
Available in 7 patterns

PART NO.	FITS
40312	3 amp - 12 Volt
40324	3 amp - 24 Volt
40612	6 amp - 12 Volt



40312

ANTI FLICKER ADAPTOR

PWM Adaptor - H13 to H4

PART NO.	FITS
55006	2007-Up Jeep JK models

H13 to H4



55006

PART NO.	FITS
55007	2007-Up Jeep JK models

RELAY

Replacement for 12V and 24V DC systems

PART NO.	FITS
49012	12V Relay
49024	24V Relay



49024

HOLSTERS

SMALL RI-SERIES FLASHLIGHT HOLSTER

Flashlight Sold Separately



PART NO.	FITS
30181	RI-600

RI-600
Shown

LARGE RI-SERIES FLASHLIGHT HOLSTER

Flashlights Sold Separately



PART NO.	FITS
30182	RI-800
	RI-1100

RI-1100
Shown

RI-800
Shown

HARDWARE

SECURITY NUT KITS

PART NO.	FITS
40282	D-Series
40283	D-Series (Heavy Duty)
40284	E-Series SR-Series
40286	SR-M Series SR-Q Series
40287	Q-Series
40288	A-Series
40289	Flush Mounts
40290	RDS-Series

**RIGID: NOW
MAKING A
THIEVES JOB
HARDER**



GRILLE EMBLEM

Stainless Steel Construction

PART NO.
46666



POP DISPLAYS

SECURITY & ACCESSORIES DISPLAY



PART NO
99990-23

INCLUDES

- (1) Point of Purchase Display
- (1) Security Kits Header Card
- (2) 40282 - D-Series Security Kit
- (2) 40283 - Heavy Duty D-Series Security Kit
- (2) 40284 - E-Series/SR-Series Security Kit
- (2) 40286 - SR-M Series/SR-Q Series Security Kit
- (2) 40287 - Q-Series Security Kit
- (2) 40288 - A-Series Security Kit
- (2) 40289 - Flush Mount Security Kit
- (2) 40290 - RDS-Series Security Kit

RIGID SLAT WALL MOUNT

PART NO
46559

INCLUDES

- (1) Slot Mount



TRUCK-LITE HEADLIGHT DISPLAY

PART NO
55103

INCLUDES

- (1) 55000 - 7" Round Headlight
- (1) 55004 - 7" Round Headed Lens Headlight



RIGID INDUSTRIES RADIANCE BACK-LIT DISPLAY

PART NO
22006

INCLUDES

- (1) 20" Radiance Display Bar Light with Automatic Back-Lit Color Changing



STANDARD COUNTER TOP POP DISPLAY

PART NO
999912

INCLUDES

- (2) D-Series Lights
- (1) 6" E-Series Light



SAE & SCENE LIGHT COUNTER TOP POP DISPLAY

PART NO
999913

INCLUDES

- (1) 2x2 Heavy Duty DC Scene Light
- (1) SAE Fog Light D-Series
- (1) 6" SAE Auxiliary E-Series



IGNITE SHIPPERS

PART NO.

LIGHTS

INCLUDED

20551

Black -
Surface Mount

- (4) Hybrid Spot - SM - Blk
- (4) Hybrid Flood - SM - Blk

60651

White -
Surface Mount

- (4) Hybrid Spot - SM - Wht
- (4) Hybrid Flood - SM - Wht

20561

Black -
Surface & Flush Mounts

- (4) Hybrid Diffused - SM - Blk
- (4) Hybrid Diffused - FM - Blk

60661

White -
Surface & Flush Mounts

- (4) Hybrid Diffused - SM - Wht
- (4) Hybrid Diffused - FM - Wht



20551



60651



20561



60661

POP DISPLAYS

ULTIMATE KIOSK DISPLAY VERSION 2

PART NO.	FEATURES
99998	<ul style="list-style-type: none"> • 17 Fully Functional Lights • Info boards • Pamphlet Holder



FLAT SCREEN WITH BUILT-IN DVD PLAYER

COUNTER TOP POP DISPLAYS

PART NO.	LIGHTS
99995	(4) SR-M Series
99991	(2) D-Series (1) E-Series
99992	(2) D-Series (White Housing) (1) E-Series (White Housing)



COUNTERTOP SHIPPERS

PART NO.	LIGHTS	INCLUDED
99911	SR-M Series	(5) SR-M Spot (5) SR-M Diffused
99912	SR-M Series (Marine)	(5) SR-M Diffused (White) (5) SR-M Diffused Flush Mount (White)
99913	A-Series	(8) Black, Low Power, Cool White (8) White, High Power, Cool White (8) Triplex, High Power, Cool White
99914	SR-M Series Backup Light Kit	(3) Back Up Light Kit boxes (3) Flush Mount Back Up Light Kit Boxes
99915	SR-Q Series Backup Light Kit	(3) Back Up Light Kit boxes (3) Flush Mount Back Up Light Kit Boxes
55100	Truck-Lite 7" Round	(4) 7" Round Headlight Kits
55101	Truck-Lite 7" Round (Heated Lens)	(4) 7" Round Heated Lens Headlight Kits
55102	Truck-Lite 5"x7"	(4) 5"x7" Headlight Kits
30127	RI-Series	(10) RI-600 White (5) RI-800 Whites
30128	RI-Series	(1) RI-600 Red (1) RI-600 Blue (1) RI-600 Green (1) RI-600 UV (1) RI-600 IR (5) R-600 White (5) R-800 White



RIGID®, Rigid Industries®, A-Series®, Rigid Industries' Capture™, D-Series®, Dually®, Dually XL™, ADAPT™, Active View™ Technology, SR-Series®, SR-M®, SR-Q®, Specter®, Hyperspot®, E-Series®, Q-Series™, R-Series®, Rigid Industries' Radiance™, RI-Series™, RI-600™, RI-800™, Reflect™, Chase, D-SS™, Ignite™, RI-1100™, RI-1500™, R-Series 46™, R-46™, R2-46™, RDS-Series®, are registered and/or common law marks owned by JST Performance, LLC, a Delaware limited liability company d/b/a Rigid Industries.

Arctic Cat® and Wildcat® are registered trademarks of Arctic Cat, Inc.
Carling® is a registered trademark of Carling Technologies, Inc.
Chevrolet®, Chevy®, 1500, 2500, 3500, Silverado® and Z71® are registered trademarks of General Motors Corporation

Cree® is a registered trademark of Cree, Inc.
Dodge®, Ram®, 2500 and 3500 are registered trademarks of Chrysler Group, LLC.
Ford®, F-150®, F-250®, F-350®, Raptor®, SVT® and Super Duty®, are registered trademarks of Ford Motor Company, Inc.

Fortrex® is a registered trademark of Johnson Outdoors, Inc.
GMC®, Z71®, Yukon®, Denali®, Sierra® and Canyon® are registered trademarks of General Motors Corporation

GOPRO, HERO, the GOPRO logo, and the GoPro Be a Hero logo are trademarks or registered trademarks of GoPro, Inc.

Core® is a registered trademark of W.L. Gore & Associates, Inc.
Hyundai® and Tucson® are registered trademarks of Hyundai Motor Company.

Honda® and CRF® are a registered trademark of Honda Motors Co., Ltd.
Jeep®, JK® and TJ® are registered trademarks of DAIMLERCHRYSLER Corporation.

Kawasaki® and Teryx® are registered trademarks of Kawasaki Heavy Industries, Ltd.
KTM® is a registered trademark of KTM-Sportmotorcycle AG Public limited company

Minn Kota® is a registered trademark of Johnson Fishing, Inc.

Nissan®, Patrol®, Titan® and Armada® are registered trademarks of Nissan Motor Co., Ltd.

Polaris®, RZR® and Ranger® are registered trademarks of Polaris Industries Inc.

Toyota®, Hilux®, Tundra®, Tacoma®, FJ Cruiser®, 4Runner® are registered trademarks of Toyota

Jidosha Kabushiki Kaisha Ta Toyota Motor Corporation

Yamaha® is a registered trademark of Yamaha Hatsudoki Kabushiki Kaisha Corporation

3M™ and VHB™ are trademarks of 3M



Warranty Information:

www.rigidindustries.com/warranty

Sales/Customer Service:

Hours of Operation: 8:00 am - 5:00 pm MST

Toll Free: 855-760-5337

Copyright February 2017

Rigid Industries LED Lighting

779 N. Colorado St, Gilbert, Arizona 85233

www.rigidindustries.com

#82539-C